

Mini Bi-spectral PTZ Network Camera User Manual



Issue

V1.1

Date

2021-07-01





Precautions

Precautions

Fully understand this document before using this device, and strictly observe rules in this document when using this device. If you install this device in public places, provide the tip "You have entered the area of electronic surveillance" in an eye-catching place. Failure to correctly use electrical products may cause fire and severe injuries. To prevent accidents, carefully read the following context:

Symbols

This document may contain the following symbols whose meanings are described accordingly.

Symbol	Description
 DANGER	It alerts you to fatal dangers which, if not avoided, may cause deaths or severe injuries.
 WARNING	It alerts you to moderate dangers which, if not avoided, may cause minor or moderate injuries.
 CAUTION	It alerts you to risks. Neglect of these risks may cause device damage, data loss, device performance deterioration, or unpredictable results.
 TIP	It provides a tip that may help you resolve problems or save time.
 NOTE	It provides additional information.

DANGER

To prevent electric shocks or other dangers, keep power plugs dry and clean.

WARNING

- Strictly observe installation requirements when installing the device. The manufacturer shall not be held responsible for device damage caused by users' non-conformance to these requirements.

- Strictly conform to local electrical safety standards and use power adapters that are marked with the LPS standard when installing and using this device. Otherwise, this device may be damaged.
- Use accessories delivered with this device. The voltage must meet input voltage requirements for this device.
- If this device is installed in places with unsteady voltage, ground this device to discharge high energy such as electrical surges in order to prevent the power supply from burning out.
- When this device is in use, ensure that no water or any liquid flows into the device. If water or liquid unexpectedly flows into the device, immediately power off the device and disconnect all cables (such as power cables and network cables) from this device.
- Do not expose the thermal imaging camera or unpacked product to extremely strong radiation sources, such as the sun, laser, or arc welding machine, regardless of whether the device is being electrified or not; do not put the camera close to high thermal objects such as the sunlight; otherwise, the precision of the camera may be affected and even the detector inside the camera may suffer a permanent damage.
- If this device is installed in places where thunder and lightning frequently occur, ground the device nearby to discharge high energy such as thunder strikes in order to prevent device damage.

**CAUTION**

- Unless otherwise specified, do not use the camera in a temperature lower than -20 °C (-4 °F) or higher than +60 °C (+140 °F). Too-high or too-low temperature may cause image display anomaly of the camera and the camera will be damaged if it is working under such a condition for a long time.
- If the camera is installed outdoors, avoid direct sunlight at dawn and dusk on the camera lens and install a sunshield with frontal and rear positions adjusted according to the sunlight angle.
- Avoid heavy loads, intensive shakes, and soaking to prevent damages during transportation and storage. The warranty does not cover any device damage that is caused during secondary packaging and transportation after the original packaging is taken apart.
- Protect this device from fall-down and intensive strikes, keep the device away from magnetic field interference, and do not install the device in places with shaking surfaces or under shocks.
- Clean the device with a soft dry cloth. For stubborn dirt, dip the cloth into slight neutral cleanser, gently wipe the dirt with the cloth, and then dry the device.
- Since the camera lens is painted with a durable coating material, it adapts to outdoor environment. The lens must be cleaned regularly. If the image quality is reduced or excessive dirt is deposited on the lens, clean the lens in a timely manner. In sandy (in desert) or corrosive (on sea) environment, use the camera with caution; improper use may cause the coating to peel off.

- Do not jam the ventilation opening. Follow the installation instructions provided in this document when installing the device.
- Keep the device away from heat sources such as radiators, electric heaters, or other heat equipment.
- Keep the device away from moist, dusty, extremely hot or cold places, or places with strong electric radiation.
- If the device is installed outdoors, take insect- and moisture-proof measures to avoid circuit board corrosion that can affect monitoring.
- Remove the power plug if the device is idle for a long time.
- Before unpacking, check whether the fragile sticker is damaged. If the fragile sticker is damaged, contact customer services or sales personnel. The manufacturer shall not be held responsible for any artificial damage of the fragile sticker.

Special Announcement

All complete products sold by the manufacturer are delivered along with nameplates, operation instructions, and accessories after strict inspection. The manufacturer shall not be held responsible for counterfeit products.

This manual may contain misprints, technology information that is not accurate enough, or product function and operation description that is slightly inconsistent with the actual product. The manufacturer will update this manual according to product function enhancement or changes and regularly update the software and hardware described in this manual. Update information will be added to new versions of this manual without prior notice.

This manual is only for reference and does not ensure that the information is totally consistent with the actual product. For consistency, see the actual product.

Contents

Precautions	i
Contents.....	iv
1 Overview	1
1.1 Principle of Thermal Imaging and Advantages	1
1.2 Product Introduction	1
1.2.1 Function	2
1.2.2 Product Features	2
1.3 Description of PTZ cable	3
2 Device Dimensions.....	5
3 Device Installation.....	6
3.1 Installation Method.....	6
3.2 Device Installation	6
3.2.1 Installation of Basic Requirements	6
3.2.2 Basic Installation Tool	6
3.2.3 Installation Space and Installation Strength	7
4 Quick Configuration.....	8
4.1 Thermal Web	8
4.1.1 Login and Logout	8
4.1.2 Main Page Layout.....	9
4.1.3 Change the Password.....	11
4.1.4 Browse Video.....	12
4.1.5 Install Plugins	14
4.1.6 Set Local Network Parameters.....	14
4.1.7 Thermal Settings	17
4.1.7.1 Temperature Parameters.....	17
4.1.7.2 Ambient Temperature.....	22
4.1.7.3 Temperature Area	23
4.1.7.4 Shield Area.....	28
4.1.7.5 Schedule Linkage.....	29
4.1.7.6 Bad Point Check	31
4.2 Visible-light Web	32
4.2.1 Login and Logout	32

4.2.2 Main Page Layout.....	33
4.2.3 Change the Password.....	35
4.2.4 Browse Video.....	36
4.2.5 Set Local Network Parameters.....	38
5 Sensor Settings	42
5.1 Access the Sensor Setting Interface	42
5.2 Sensor Setting Parameters of Thermal.....	43
5.2.1 Mode.....	43
5.2.2 Image Setting.....	43
5.2.3 Scene.....	45
5.2.4 Set Pseudocolor.....	45
5.2.5 FFC Control.....	46
5.2.6 Lens Control	48
5.2.7 Noise Reduction.....	49
5.2.8 Enhance Image.....	50
5.3 Sensor Setting Parameters of Visible Light	51
5.3.1 Mode.....	51
5.3.2 Image Adjust.....	53
5.3.3 Scene.....	54
5.3.4 Exposure	55
5.3.5 WB.....	56
5.3.6 DayNight	57
5.3.7 Noise Reduction.....	60
5.3.8 Enhance Image.....	60
5.3.9 Zoom Focus	62
6 PTZ Function Application	64
6.1 PTZ Control function.....	64
6.2 PTZ configuration.....	65
6.2.1 PTZ Setting.....	65
6.2.2 Configure and Apply Preset.....	66
6.2.3 Configure and Apply Tracks	66
6.2.4 Configure and Apply Scan.....	67
6.2.5 Configure and Apply Tour	68
6.2.6 Configure and Apply Idle.....	69
6.2.7 Configure Timer.....	70
6.2.8 Configure Extension	72

A Troubleshooting 74
B Common Emission Rate 77

1 Overview

1.1 Principle of Thermal Imaging and Advantages

Any object with temperature higher than the absolute zero (-273.15° F) will emit infrared (IR) ray, even though it does not emit light. The IR ray is also called thermal radiation. IR rays emitted by objects with different temperatures can be absorbed by the detector to reflect temperature change and thus generate an electric effect. The electric signal is amplified and processed to produce a thermal image that corresponds to the thermal distribution of the object surface. This is the process of thermal imaging.

- Adapt to any environment

Traditional cameras rely on natural or environmental light to shoot images, but this IR thermal imaging camera relies on the IR energy radiated by an object itself to form an image, not requiring any light. The IR thermal imaging camera is applicable to any environment and not affected by light strength. It can detect and identify any camouflage and concealed object both in daytime or nighttime, implementing round-the-clock monitoring.

- Monitor the temperature field with object energy distributed

The IR thermal imaging camera can show the temperature field of an object, converting the invisible surface temperature distribution situation to a visible thermal image that reflects the surface temperature distribution situation of the object. By this monitoring, users can discover temperature anomaly in a timely manner and take precautionary measures to avoid any risk that may be caused by the anomaly, for example, a fire.

- Boast cloud penetration capability

Visible light and near IR ray will be absorbed by the air, cloud and smoke, but they are transparent to IR ray of the 3~5 μm Medium Wavelength Infrared (MWIR) region and 8~14 μm Long Wavelength Infrared (LWIR) region. Traditional cameras cannot shoot clear images under cloudy environment, but the IR thermal imaging camera can penetrate the cloud and smoke to shoot clear images.

1.2 Product Introduction

Mini Bi-spectral PTZ Network Camera the whole machine shell and the base are all made of high strength aluminum alloy material with comprehensive function and high stability. Can adapt to a variety of bad environment, heavy load can reach

more than 50 kg and run smoothly. This series has 360° continuous rotation, automatic scanning, automatic cruise and other functions, suitable for large areas of monitoring, can be widely used in airports, stations, urban roads, traffic survey and monitoring, forest fire prevention, the high and heavy equipment rotary control and other important area.

1.2.1 Function

- To support a variety of scanning methods, such as cruise scan, pattern scanning, etc.
- It supports the function of power off memory and automatically returns to the monitoring scene before power off.
- Support network signal and analog signal double output, cloud platform control classification operation.
- The double helix structure of worm gear and worm drive, the electronic image stabilization, and mechanical locking design, power self-locking function.
- Horizontal continuous rotation 360°, vertically +90° ~- 90° rotating, horizontal velocity is 0.01°~30 °/S, vertical speed of 0.01° ~ 10°/S.
- Support proportion variable times function, rotation speed adjusted automatically according to the lens change multiple times.
- Support watch features preset point/figure/cruise can stay idle scan specified Automatic call after time (including the idle state entered after power).

1.2.2 Product Features

- Outdoor intelligent variable speed PTZ, the fuselage selection of high strength aluminum alloy material, exterior design can resist strong winds, smooth operation, high precision.
- Products using high-precision stepper motor and precision worm gear drive combination, power can be self-locking.
- Support a variety of lens preset function, zoom adaptive function, the rotation speed can be automatically adjusted according to the lens zoom factor.
- Powerful, with preset, cruise, line sweep, keep watch and other functions.
- Visual pitch angle range, monitoring a wide range of horizontal speed up to 10°/ s.
- Equipment has its own automatic heating system, low temperature automatically start heating function, to ensure that products can be applied to cold areas.
- Network transmission signal can reach 100 Mbps.
- Device supports RS485 / RS422 communication interface, you can remotely upgrade the device program, easy to maintain.
- Power failure memory function, accidental power after re-power, the memory of the last running state, can be restored to power before running state.

1.3 Description of PTZ cable

The cables are shown as Figure 1-1, and the description is shown in Table 1-1.

Figure 1-1 Aviation power supply and network cable of twenty-six cores

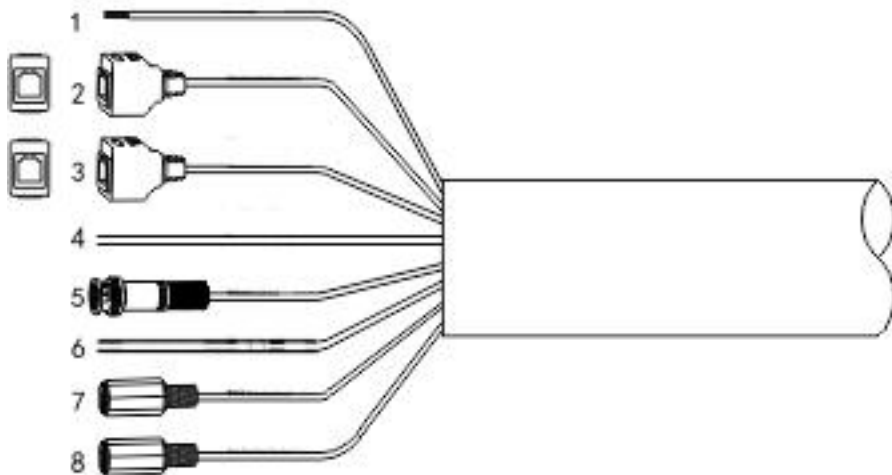

Table 1-1 Description of twenty-six cores

SN	Name	Core	Function	Description
1	Power supply	Red	DC24V	-
		black	GND	-
		Yellow & green	Ground	-
2	Network interface of Thermal channel	-	Interwork interface	Connect to standard Ethernet cable
3	Network interface of visual channel	-	Interwork interface	Connect to standard Ethernet cable
4	RS485 port	Orange	RS485A	-
		Yellow	RS485B	-
5	CVBS	-		Output analog video signal
6	Alarm port	Blue	Alarm 1	-

SN	Name	Core	Function	Description
		Pink	Alarm 2	-
7	Audio input	Red	Audio input positive	-
		White	Audio input negative	-
8	Audio output	Red	Audio output positive	-
		White	Audio output negative	-

**NOTE**

In order to prevent lightning strikes, the grounding wire (yellow-green wire) in the cable outlet base must be grounded reliably and the grounding resistance should be $<4\Omega$.

---End

2 Device Dimensions

Figure 2-1 shows the dimensions of the Mini Bi-spectral PTZ Network Camera.

Figure 2-1 Dimensions (unit: mm)

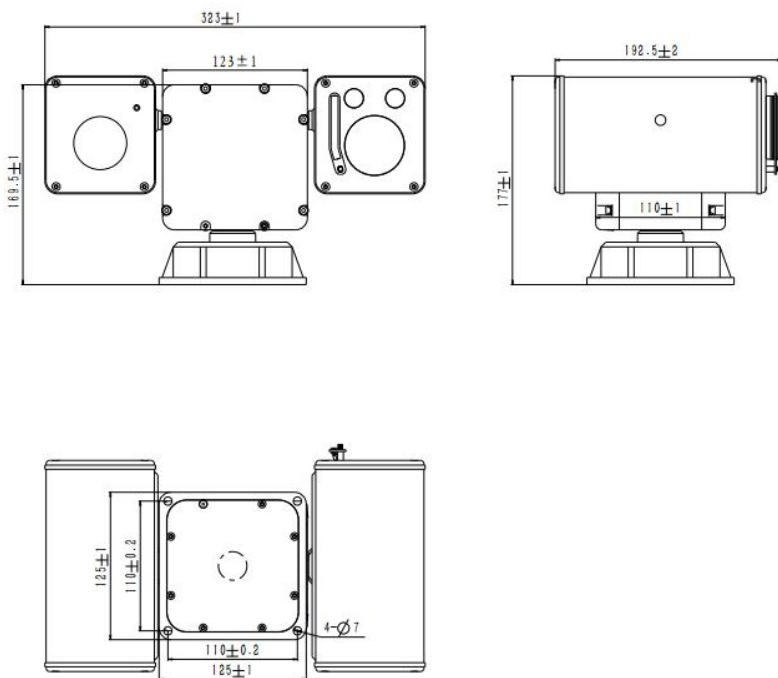

3 Device Installation

3.1 Installation Method

Mini Bi-spectral PTZ Network Camera can be installed on camera base. Figure 3-1 shows the base dimensions of PTZ camera.

Figure 3-1 Base dimensions of PTZ camera (unit: mm)

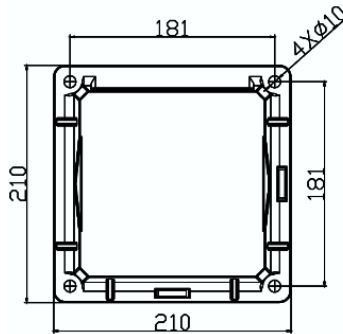

3.2 Device Installation

3.2.1 Installation of Basic Requirements

Installation site and environment to meet the technical parameters mentioned in the requirements, the installation staff should have been fully read and read the contents of this manual, with the appropriate system installation qualification and maintenance work qualification certificate.

3.2.2 Basic Installation Tool

Commonly used engineering wiring and equipment installation tools, please install the equipment before the preparation is complete.

Table 3-1 shows the installation tools list.

Table 3-1 Installation tools

Name	Quantity	Remarks
13mm wrench	1	For mounting fixtures and mounting brackets
14mm sleeve	1	
Cross screwdriver(big)	1	For common construction
Cross screwdriver(small)	1	Used to disassemble the DIP cover to adjust the device communication parameters
Inside the hex wrench	1 set	Used for disassembly of pan / tilt pallet and shield connection
Word screwdriver (small)	1	to secure the wiring harness connection terminals
Wire strippers	1	Stripping

3.2.3 Installation Space and Installation Strength

Under normal circumstances, this device needs to be equipped with a protective cover or other overhead items, please confirm the installation location can accommodate this product and the equipment and installation of the structure of the space. To confirm the installation of the wall, the carrying capacity of the bracket can reach 4 times the safety of the entire equipment weight.

---End

4 Quick Configuration

4.1 Thermal Web

4.1.1 Login and Logout



CAUTION

You must use Internet Explorer 8 or a later version to access the web management system; otherwise, some functions may be unavailable.

Login system

Step 1 Open the Internet Explorer, enter the IP address of IP camera (default value: 192.168.0.121) in the address box, and press Enter.

The login page is displayed, as shown in Figure 4-1.

Figure 4-1 Login page

The screenshot shows the login interface for an IP camera. It features a light blue header with the text 'IP CAMERA' in a large, blue, stylized font. To the right of the header is a language selection dropdown menu currently set to 'English'. Below the header, there are two text input fields: one for 'User Name' and one for 'Password'. To the right of these fields is a blue button labeled 'Login'.

Step 2 Input the User name and password.

NOTE

- The default user name is **admin**. The default password is **admin**. Change the password when you log in the system for first time to ensure system security.
- It is advised to restarted the camera three minutes later after modifying password.
- You can change the system display language on the login page.

Step 3 Click Login.

The main page is displayed.

---End

logout

To logout of system, click  in the upper right corner of the main page, the login page is display after you log out of the system.

4.1.2 Main Page Layout



On the main page, you can view real-time video, set parameter, Video parameter, Video control, PTZ control, PTZ Configure and log out of the system. Figure 4-2 is shown the main page layout. Table 4-1 lists the elements on the main page layout.

Figure 4-2 Main page layout



Table 4-1 Elements on the main page

No.	Element	Description
1	Real-time video area	Real-time videos are played in this area. You can also set sensor parameters.
2	Playback	You can query the playback videos in this area.

No.	Element	Description
		NOTE Only when the SD card has videos that user can query the playback videos.
3	Device configuration	You can choose a menu to set device parameters, including the device information, audio and video streams, alarm setting, and privacy mask function.
4	Change password	You can click  to change the password.
5	Sign Out	You can click  to return to the login page.
6	Stream	There are three streams. Choose one type from drop-down list.
7	PTZ	Click to enter the PTZ interface.
8	Pause/Start	Close live video or play live video.
9	Live/Smooth	Switch image quality.
10	Audio	Open or close audio.
11	Interphone	Open or close interphone.
12	Sensor setting	Click the icon, it will access to sensor setting.
13	Snapshot	Click the icon, it will snapshot.
14	Local record	Click the icon, it will record video and save.
15	Intelligent analysis	Open the intelligent, choose the stream to stream 2, click to open the intelligent analysis, it will show target information and video stream draw line after you have turned on the function in IVS settings.

NOTE





1. When the device generates an alarm, the alarm icon  is displayed. You can click  to view the alarm information. When the device accepts an alarm signal, the alarm icon will display within 10s in the web management system.
2. When the device encounters an exception, the fault icon  is displayed. You can click  to view the fault information.

Figure 4-3 Displaying temperature



:the lowest temperature of full screen.



: the highest temperature of full screen.



: the lowest temperature of area.



: the highest temperature of area.

---End

4.1.3 Change the Password

Description

You can click  to change the password for logging in to the system.

Procedure

Step 1 Click  in the upper right corner of the main page.

The **Change Password** dialog box is displayed, as shown in Figure 4-4.

Figure 4-4 Modify Password dialog box

Change Password X

Old Password	<input type="text"/>
New Password	<input type="text"/>
Confirm	<input type="text"/>

Password Advice:

1. Advice the password length of eight characters.
2. Advice the password includes numbers, capital letters, lowercase letters and special characters.
3. Advice the password can not be the same as username.

 **NOTE**

The change password page will be displayed if you don't change the default password when you login the system for the first time.

Step 2 Enter the old password, new password, and confirmation password.

Step 3 Click **OK**.

If the message "Change password success" is displayed, the password is successfully changed. If the password fails to be changed, the cause is displayed. (For example, the new password length couldn't be less than eight.)

Step 4 Click **OK**.

The login page is displayed.

----End

4.1.4 Browse Video

User can browse the real-time video in the web management system.

Preparation

To ensure the real-time video can be play properly, you must perform the following operation when you log in to the web for the first time:

Step 1 Open the Internet Explorer. **Choose Tools > Internet options > Security > Trusted sites > Sites.**

In the display dialog box, click **Add**, as shown in Figure 4-5.

Figure 4-5 Adding the a trusted site

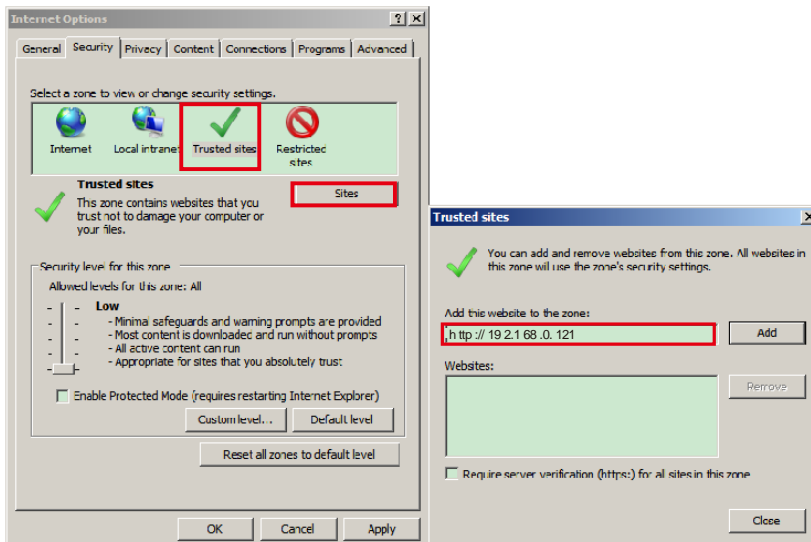

Step 2 In the Internet Explorer, choose **Tool > Internet Options > Security > Customer level**, and set Download unsigned ActiveX control and initialize and script ActiveX controls not marked as safe for scripting under ActiveX controls and plug-ins to Enable, as shown in Figure 4-6.

Figure 4-6 Configuring ActiveX control and plug-ins

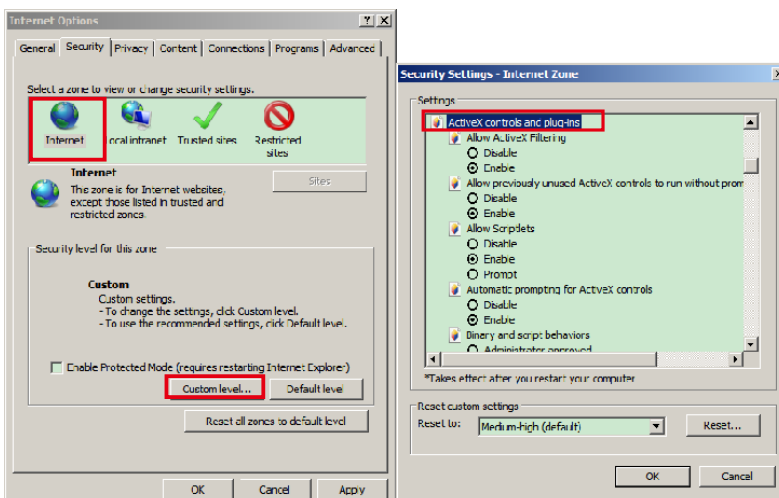

Step 3 Download and install the player control as prompted.

 **NOTE**

The login page is display when the control is loaded.

4.1.5 Install Plugins

You will be prompted with a message “Download and install the new plugin” as shown in Figure 4-7 when you log in to the web management system for the first time.

Figure 4-7 Download the plugin page

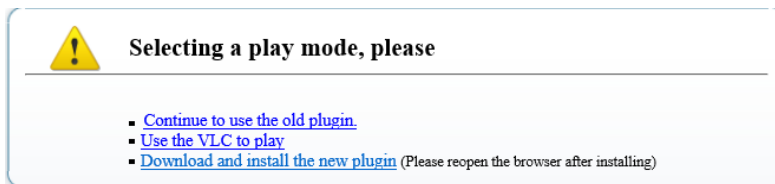

Procedure

Step 1 Click the message, download and install the plugin follow the prompts.

Step 2 Reopen the browser after installation.

----End

4.1.6 Set Local Network Parameters

Description

Local network parameters include:

- IP protocol
- IP address
- Subnet mask
- Default gateway
- Dynamic Host Configuration Protocol (DHCP)
- Preferred Domain Name System (DNS) server
- Alternate DNS server
- MTU

Procedure

Step 1 Choose **Configuration > Device >Local Network**.

The **Local Network** page is displayed, as shown in Figure 4-8.

Figure 4-8 Local Network page

Local Network

Network Card ID

IP Protocol

DHCP OFF

IP Address

Subnet Mask

Default Gateway

Preferred DNS Server

Alternate DNS Server

MTU(1280-1500)

Step 2 Set the parameters according to Table 4-2.

Table 4-2 Local network parameters

Parameter	Description	Setting
IP Protocol	IPv4 is the IP protocol that uses an address length of 32 bits.	[Setting method] Select a value from the drop-down list box. [Default value] IPv4
DHCP	The device automatically obtains the IP address from the DHCP server.	[Setting method] Click the option button. NOTE To query the current IP address of the device, you must query it on the platform based on the device name.
DHCP IP	IP address that the DHCP server assigned to the device.	N/A

Parameter	Description	Setting
IP Address	Device IP address that can be set as required.	[Setting method] Enter a value manually. [Default value] 192.168.0.121
Subnet Mask	Subnet mask of the network adapter.	[Setting method] Enter a value manually. [Default value] 255.255.255.0
Default Gateway	This parameter must be set if the client accesses the device through a gateway.	[Setting method] Enter a value manually. [Default value] 192.168.0.1
Preferred DNS Server	IP address of a DNS server.	[Setting method] Enter a value manually. [Default value] 192.168.0.1
Alternate DNS Server	IP address of a domain server. If the preferred DNS server is faulty, the device uses the alternate DNS server to resolve domain names.	[Setting method] Enter a value manually. [Default value] 192.168.0.2
MTU	Set the maximum value of network transmission data packets.	[Setting method] Enter a value manually. NOTE The MTU value is range from 1280 to 1500, the default value is 1500, Please do not change it arbitrarily.

Step 3 Click **OK**.

- If the message "Apply success" is displayed, click OK. The system saves the settings. The message "Set network param's success, Please login system again" is displayed. Use the new IP address to log in to the web management system.
- If the message "Invalid IP Address", "Invalid Subnet Mask", "Invalid default gateway", "Invalid primary DNS", or "Invalid space DNS" is displayed, set the parameters correctly.



NOTE

- If you set only the **Subnet Mask**, **Default Gateway**, **Preferred DNS Server**, and **Alternate DNS Server** parameters, you do not need to log in to the system again.
- You can click **Reset** to set the parameters again if required.

---End

4.1.7 Thermal Settings

4.1.7.1 Temperature Parameters

Temperature parameters include: temperature unit, ambient type, ambient temperature, cavity temperature, correctional coefficient and area temperature display mode.

Operation Procedure

Step 1 Choose **Configuration >Thermal >Temperature Parameters**.

The **Temperature Parameters** page is displayed, as shown in Figure 4-9.

Figure 4-9 Temperature Parameters interface

 Temperature Parameters

Open Temperature Measure
 ON

Temperature Unit	Celsius
Ambient Temperature	25.00
Cavity Temperature	39.24
Correction Coefficient	0.00
Area Temperature Display Mode	Low Left
Font Border	<input checked="" type="checkbox"/> ON
Custom Colors	<input type="checkbox"/> OFF
Font Size	Mid
Area Temperature Type	Highest Temperature
Measure Mode	General
Display Alarm Area	<input type="checkbox"/> OFF
Area Alarm Interval(1-1800S)	10
Area Alarm Delay(0-10Sec)	0
Temperature Range	-40.0 ~ 150.0
Prevent Over Heat	Auto
Temper Duration(5-60Sec)	60

Advanced

Refresh
Apply

Step 2 Set the parameters according to Table 4-3.

Table 4-3 Temperature parameters

Parameter	Description	Setting
Temperature Unit	Celsius and Fahrenheit temperature units are available.	[Setting method] Select a value from the drop-down list box. [Default value] Celsius

Parameter	Description	Setting
Ambient Temperature	The ambient temperature of camera. It is set when ambient is outside.	[Setting method] Enter a value manually.
Cavity Temperature	The cavity temperature of camera.	N/A
Correction Coefficient	Correction coefficient is refer to the deviation of measured object temperature and actual temperature. For example: 1. The measured object temperature is 30, and actual temperature is 37, so the correction coefficient should be 7 . 2. The measured object temperature is 37, and actual temperature is 30, so the correction coefficient should be -7 .	[Setting method] Enter a value manually. [Default value] 0.00
Area Temperature Display Mode	The display position of temperature information on the live-video image.	[Setting method] Select a value from the drop-down list box. [Default value] Low left
Font Border	The font will be bolded.	[Setting method] Enable or disable [Default value] disable
Custom Colors	Enable to custom the color, there are nine colors chosen.	[Setting method] Enable or disable [Default value] disable
Area Temperature Type	There are three types of area temperature, such as highest temperature, highest temperature & lowest temperature, highest temperature & lowest temperature & average temperature.	[Setting method] Select a value from the drop-down list box. [Default value] Highest Temperature

Parameter	Description	Setting
Measure Mode	There are two types measure modes.	[Setting method] Select a value from the drop-down list box. [Default value] General
Display Alarm Area	N/A	[Setting method] Enable or disable [Default value] disable
Area Alarm Interval (1-1800 s)	N/A	[Setting method] Enter a value manually ranges from 1 to 1800. [Default value] 10
Area Alarm Delay(0-10 sec)	When the temperature is reaching the setting value, and lasting for the delay time, it will be alarm.	[Setting method] Enter a value manually ranges from 1 to 10.
Temperature Range	Select the applicable range of the thermal imaging camera.	[Setting method] Select a value from the drop-down list box.
Prevent Over Heat	Open, if temperature of the testing area is too high, you can enable prevent over heat function, there are two manners, manual and auto.	[Setting method] Select a value from the drop-down list box.
Temper Duration(5-60 S)	Prevent over heat' mode is auto, the control cover will block for duration time automatically if over heat.	[Setting method] Enter a value manually ranges from 5 to 60.
Control Cover	Prevent over heat' mode is manual, the user should choose the action manually, such as pick up, lay down.	[Setting method] Select a value from the drop-down list box.

Figure 4-10 Advanced parameter

Dimming Mode	Auto
Greater Prominent	<input type="checkbox"/> ON
Temperature	35
Color	
Section Prominent	<input type="checkbox"/> ON
Minimum Temperature	35.0
Maximum Temperature	37
Color	
Less Prominent	<input type="checkbox"/> ON
Temperature	26
Color	
Raw Data Upload Interval(F/S)	1
Mix Stream Mode	Close

Table 4-4 Advanced parameters

Parameter	Description	Setting
Dimming Mode	There are auto and manual modes. It will show on temperature item.	[Setting method] Select a value from the drop-down list box. [Default value] Auto
Greater Prominent	Enable that, the image will show the setting color if the temperature is higher than set value.	[Setting method] Enter a value manually. Choose one color to show.
Section Prominent	Enable that, the image will show the setting color if the temperature is between minimum and maximum temperature.	[Setting method] Enter a value manually. Choose one color to show.

Parameter	Description	Setting
Less Prominent	Enable that, the image will show the setting color if the temperature is lower than set value.	[Setting method] Enter a value manually. Choose one color to show.
Raw Data Upload Interval(F/S)	Interval of Upload the raw data.	[Setting method] Select a value from the drop-down list box. [Default value] 1
Mix Stream Mode	This function is used for thermal and visible lighting image to mix.	[Default value] Close

Step 3 Click **Apply**.

The message "Apply success" is displayed, the system saves the settings.

---End

4.1.7.2 Ambient Temperature

Set the ambient temperature of camera, click "Apply" to save the setting, click "Refresh" the adaptation environment temperature will be refresh based on ambient temperature.

Figure 4-11 Ambient temperature

Ambient Temperature

Ambient Temperature	<input type="text" value="25.00"/>	°C
Adaptation Environment Temperature	<input type="text" value="23.98"/>	°C

Table 4-5 Parameter of ambient temperature

Parameter	Description	Setting
Ambient Temperature	Environment temperature of camera.	[Setting method] Enter the temperature of ambient. [Default value] 25

Parameter	Description	Setting
Adaptation environment temperature	Set the ambient temperature, click “Apply”, click “Refresh” ,the camera will get the value automatically.	---

---End

4.1.7.3 Temperature Area

Operation Procedure

Step 1 Choose **Configuration >Thermal >Temperature Area**.

The **Temperature Area** page is displayed, as shown in Figure 4-12.

Figure 4-12 Temperature area and alarm configuration

 Temperature Area And Alarm Configuration

Channel Measure Mode

2021-03-19 23:13:43 Fri



[00] 50.3

- +



Enable	ID	Name	Type	Alarm Type	Warning Value	Alarm Value	Maximum Alarm Va	Duration(1-1)
<input checked="" type="checkbox"/>	0	Area0	Rectangle	Threshold Alarm	48.00	50.00	60.00	1.00
<input type="checkbox"/>	1	Area1	Point	Threshold Alarm	48.00	50.00	60.00	1.00
<input type="checkbox"/>	2	Area2	Point	Threshold Alarm	48.00	50.00	60.00	1.00
<input type="checkbox"/>	3	Area3	Point	Threshold Alarm	48.00	50.00	60.00	1.00
<input type="checkbox"/>	4	Area4	Point	Threshold Alarm	48.00	50.00	60.00	1.00
<input type="checkbox"/>	5	Area5	Point	Threshold Alarm	48.00	50.00	60.00	1.00
<input type="checkbox"/>	5	Area5	Point	Threshold Alarm	48.00	50.00	60.00	1.00
<input type="checkbox"/>	6	Area6	Point	Threshold Alarm	48.00	50.00	60.00	1.00
<input type="checkbox"/>	7	Area7	Point	Threshold Alarm	48.00	50.00	60.00	1.00

Step 2 Set the parameters according to Table 4-6.

Table 4-6 Temperature area and alarm configuration

Parameter	Description	Setting
Channel	N/A	[Setting method] Select a value from the drop-down list box. [Default value] 1
Measure Mode	Set at temperature parameter interface.	N/A
Name	Area name of temperature area.	[Setting method] Enter a value manually.
Type	Type of temperature area. ID 0 is default rectangle area, which is full screen.	[Setting method] Select a value from the drop-down list box. [Default value] Rectangle/Point
Alarm Type	Threshold alarm, temperature difference alarm, section alarm, temperature rise alarm are available for alarm type. Section Alarm: if the temperature value is among the set temperature range, it will generate the alarm. Temperature rise alarm means it the rising temperature value is more than the set value, it will generate the alarm. It need to set the alarm schedule	[Setting method] Select a value from the drop-down list box. [Default value] Threshold alarm
Warning Value	Camera will trigger warning alarm when the object temperature reaches the warning value.	[Setting method] Enter a value manually. [Default value] 48
Alarm Value	Camera will alarm when the object temperature reaches the alarm value.	[Setting method] Enter a value manually. [Default value] 50
Maximum Alarm Value	At section alarm type, the device would not alarm when the temperature is higher than maximum alarm value.	[Setting method] Enter a value manually. [Default value] 60.00

Parameter	Description	Setting
Duration (1-10S)	Choose temperature rise alarm, set the duration, the temperature rise the value and it is kept for duration setting, the alarm is triggered successfully.	
Emission Rate	The emission rate is the capability of an object to emit or absorb energy. The emission rate should be set only when the target is special material. The emission rate list refers to Common Emission Rate	[Setting method] Enter a value manually. [Default value] 0.95
Distance(M)	The distance between camera and target.	[Setting method] Enter a value manually. [Default value] 15  NOTE Enter actual distance when the distance between camera and target is less than 15m. Enter 15 when the distance between camera and target is great than or equal to 15m.
Alarm	Enable or disable the alarm output and linkage of area.	[Setting method] Tick the alarm output channel .

Parameter	Description	Setting
Group ID	<p>The ID can be chosen into one of six groups, or no group. The group will be alarm following as the next rules:</p> <p>A=The highest temperature of groups (the highest temperature of N regions is the largest)</p> <p>B=Average temperature of groups (average temperature of N regions)</p> <p>WA=Warning value</p> <p>AA=Alarm value</p> <p>a. If $A-B \geq WA$, a temperature difference warning signal is generated ---> (the one with the largest difference between the N areas and the average temperature is the alarm area flashing)</p> <p>b. If $A-B \geq AA$, a temperature difference alarm signal is generated ---> (the one with the largest difference between the N areas and the average temperature is the alarm area flashing)</p> <p>c. If the warning and alarm conditions are met at the same time, the alarm signal will be generated first.</p>	<p>[Setting method]</p> <p>Select a value from the drop-down list box.</p>

Step 3 Set temperature area.

1. Tick an area ID.
2. Select type from drop-list.
3. Press and hold the left mouse button, and drag in the video area to draw a temperature area, as shown in Figure 4-13. Right-click to finish the area selected.

Figure 4-13 Temperature Area Setting Interface

 Temperature Area And Alarm Configuration

Channel
1

Measure Mode
General

2021-07-28 03:36:25 Wed

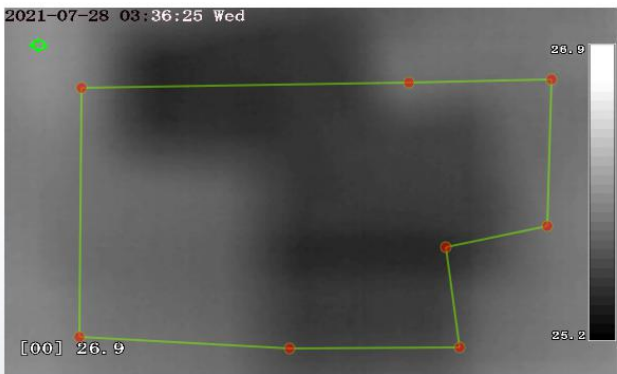

-

+
6
+



[F1]
[F2]
[F3]
[F4]
[F5]

Enable	ID	Name	Type	Alarm Type	Warning Value	Alarm Value	Maximum Alarm Va	Duration(1-1)
<input checked="" type="checkbox"/>	0	Area0	Rectangle	Threshold Alarm	48.00	50.00	60.00	1.00
<input checked="" type="checkbox"/>	1	Area1	Polygon	Threshold Alarm	48.00	50.00	60.00	1.00
<input type="checkbox"/>	2	Area2	Point	Threshold Alarm	48.00	50.00	60.00	1.00

- Click **Apply**, the message “Apply success” is displayed, the temperature area is set successfully.

Delete a temperature area:

- Select an area ID.
- Click the temperature area and right-click.
- Remove the tick of area ID.
- Click **Apply**, the message “Apply success” is displayed, the temperature area is deleted successfully.

Step 4 Click Apply.

The message "Apply success" is displayed, the system saves the settings.

---End

4.1.7.4 Shield Area

Shield area is meaning that the camera will do not detect the temperature of that area. The shield areas can be set up to four areas.

Operation Procedure

Step 1 Choose **Configuration > Thermal > Shield Area**.

Figure 4-14 Shield Area

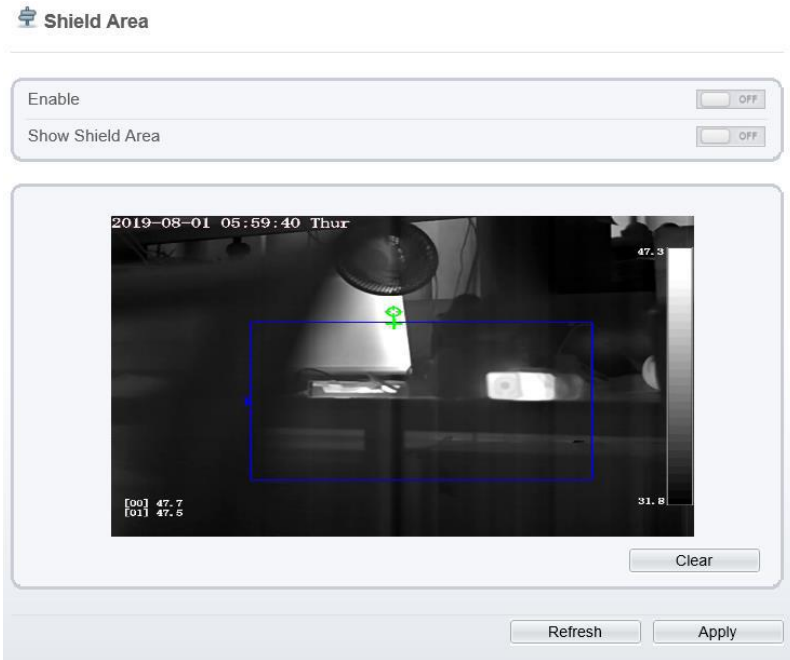

Step 2 Enable the shield area.

Step 3 Enable **Show Shield Area**, then the setting shield will show on live video.

Step 4 Click left mouse button to set area, click right mouse button to end the setting.

Step 5 Click **Clear** to clear the shield area.

---End

4.1.7.5 Schedule Linkage

Operation Procedure

Step 1 Choose **Configuration > Thermal > Schedule Linkage**

The **Schedule Linkage** page is displayed, as shown in Figure 4-15.

Figure 4-15 Schedule Linkage

 **Schedule Linkage**

Threshold Alarm
Threshold Warning
Temperature Differenc
Temperature Differenc
Temperature Section /

Temperature Rise Alai
Temperature Rise Wa

Output Channel
 1 2

PTZ Linkage
 OFF

Alarm Record
 OFF

SMTP
 OFF

FTP Upload
 OFF

Audio Detect Alarm
 OFF

	0	1	2	3	4	5	6	7	8	9	10	11	12	13	14	15	16	17	18	19	20	21	22	23	24
Sun	<input type="checkbox"/>	<input type="checkbox"/>	<input type="checkbox"/>	<input type="checkbox"/>	<input type="checkbox"/>	<input type="checkbox"/>	<input type="checkbox"/>	<input type="checkbox"/>	<input type="checkbox"/>	<input type="checkbox"/>	<input type="checkbox"/>	<input type="checkbox"/>	<input type="checkbox"/>	<input type="checkbox"/>	<input type="checkbox"/>	<input type="checkbox"/>	<input type="checkbox"/>	<input type="checkbox"/>	<input type="checkbox"/>	<input type="checkbox"/>	<input type="checkbox"/>	<input type="checkbox"/>	<input type="checkbox"/>	<input type="checkbox"/>	<input type="checkbox"/>
Mon	<input type="checkbox"/>	<input type="checkbox"/>	<input type="checkbox"/>	<input type="checkbox"/>	<input type="checkbox"/>	<input type="checkbox"/>	<input type="checkbox"/>	<input type="checkbox"/>	<input type="checkbox"/>	<input type="checkbox"/>	<input type="checkbox"/>	<input type="checkbox"/>	<input type="checkbox"/>	<input type="checkbox"/>	<input type="checkbox"/>	<input type="checkbox"/>	<input type="checkbox"/>	<input type="checkbox"/>	<input type="checkbox"/>	<input type="checkbox"/>	<input type="checkbox"/>	<input type="checkbox"/>	<input type="checkbox"/>	<input type="checkbox"/>	<input type="checkbox"/>
Tues	<input type="checkbox"/>	<input type="checkbox"/>	<input type="checkbox"/>	<input type="checkbox"/>	<input type="checkbox"/>	<input type="checkbox"/>	<input type="checkbox"/>	<input type="checkbox"/>	<input type="checkbox"/>	<input type="checkbox"/>	<input type="checkbox"/>	<input type="checkbox"/>	<input type="checkbox"/>	<input type="checkbox"/>	<input type="checkbox"/>	<input type="checkbox"/>	<input type="checkbox"/>	<input type="checkbox"/>	<input type="checkbox"/>	<input type="checkbox"/>	<input type="checkbox"/>	<input type="checkbox"/>	<input type="checkbox"/>	<input type="checkbox"/>	<input type="checkbox"/>
Wed	<input type="checkbox"/>	<input type="checkbox"/>	<input type="checkbox"/>	<input type="checkbox"/>	<input type="checkbox"/>	<input type="checkbox"/>	<input type="checkbox"/>	<input type="checkbox"/>	<input type="checkbox"/>	<input type="checkbox"/>	<input type="checkbox"/>	<input type="checkbox"/>	<input type="checkbox"/>	<input type="checkbox"/>	<input type="checkbox"/>	<input type="checkbox"/>	<input type="checkbox"/>	<input type="checkbox"/>	<input type="checkbox"/>	<input type="checkbox"/>	<input type="checkbox"/>	<input type="checkbox"/>	<input type="checkbox"/>	<input type="checkbox"/>	<input type="checkbox"/>
Thur	<input type="checkbox"/>	<input type="checkbox"/>	<input type="checkbox"/>	<input type="checkbox"/>	<input type="checkbox"/>	<input type="checkbox"/>	<input type="checkbox"/>	<input type="checkbox"/>	<input type="checkbox"/>	<input type="checkbox"/>	<input type="checkbox"/>	<input type="checkbox"/>	<input type="checkbox"/>	<input type="checkbox"/>	<input type="checkbox"/>	<input type="checkbox"/>	<input type="checkbox"/>	<input type="checkbox"/>	<input type="checkbox"/>	<input type="checkbox"/>	<input type="checkbox"/>	<input type="checkbox"/>	<input type="checkbox"/>	<input type="checkbox"/>	<input type="checkbox"/>
Fri	<input type="checkbox"/>	<input type="checkbox"/>	<input type="checkbox"/>	<input type="checkbox"/>	<input type="checkbox"/>	<input type="checkbox"/>	<input type="checkbox"/>	<input type="checkbox"/>	<input type="checkbox"/>	<input type="checkbox"/>	<input type="checkbox"/>	<input type="checkbox"/>	<input type="checkbox"/>	<input type="checkbox"/>	<input type="checkbox"/>	<input type="checkbox"/>	<input type="checkbox"/>	<input type="checkbox"/>	<input type="checkbox"/>	<input type="checkbox"/>	<input type="checkbox"/>	<input type="checkbox"/>	<input type="checkbox"/>	<input type="checkbox"/>	<input type="checkbox"/>
Sat	<input type="checkbox"/>	<input type="checkbox"/>	<input type="checkbox"/>	<input type="checkbox"/>	<input type="checkbox"/>	<input type="checkbox"/>	<input type="checkbox"/>	<input type="checkbox"/>	<input type="checkbox"/>	<input type="checkbox"/>	<input type="checkbox"/>	<input type="checkbox"/>	<input type="checkbox"/>	<input type="checkbox"/>	<input type="checkbox"/>	<input type="checkbox"/>	<input type="checkbox"/>	<input type="checkbox"/>	<input type="checkbox"/>	<input type="checkbox"/>	<input type="checkbox"/>	<input type="checkbox"/>	<input type="checkbox"/>	<input type="checkbox"/>	<input type="checkbox"/>

Refresh
Apply

Step 2 Tick the output channel.

Step 3 Enable “PTZ Linkage”, “Alarm Record”, “SMTP”, “FTP” button.

Step 4 Set schedule linkage.

Method 1: Click left mouse button to select any time point within 0:00-24:00 from Monday to Sunday as shown in Figure 4-15.

Method 2: Hold down the left mouse button, drag and release mouse to select the alarm time within 0:00-24:00 from Sunday to Saturday.

NOTE

When you select time by dragging the cursor, the cursor cannot be moved out of the time area. Otherwise, no time can be selected.

Method 3: Click  in the alarm time page to select the whole day or whole week.

Deleting alarm time: Click  again or inverse selection to delete the selected alarm time.

Step 5 Click **Apply**.

The message "Apply success" is displayed, the system saves the settings.

---End

4.1.7.6 Bad Point Check

Description

The points that can't move when the environment or scenario change is bad point. You can delete the bad point by bad point check function.

Procedure

Step 1 Choose **Configuration > Thermal > Bad Point Check**

The **Bad Point Check** page is displayed, as shown in Figure 4-16.

Figure 4-16 Bad Point Check



Step 2 Click the white point at image, click **Apply** to recover the bad point, as shown in Figure 4-17

Figure 4-17 Recover bad point



Step 3 Click **Reset** to return the previous settings.

Step 4 Click **Apply**. The message "Apply success" is displayed, the system saves the settings.

---End

4.2 Visible-light Web

4.2.1 Login and Logout



CAUTION

You must use Internet Explorer 8 or a later version to access the web management system; otherwise, some functions may be unavailable.

Login system

Step 1 Open Internet Explorer, enter the IP address of the IP camera (default value: 192.168.0.120) in the address box, and press **Enter**.

The login page is displayed, as shown in Figure 4-18.

Figure 4-18 Login page

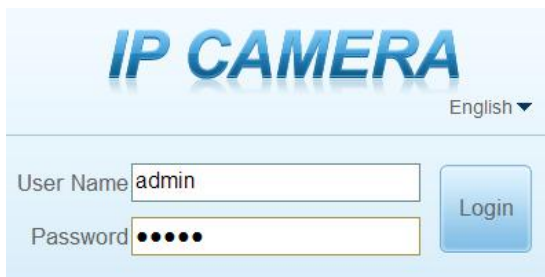

Step 2 Enter the user name, and password.

 **NOTE**

- The default user name is admin. The default password is admin.
- Please change the password to ensure system security.
- You can change the system display language on the login page.

Step 3 Click login.

The main page is displayed.

---End

Logout

To log out of the system, click  in the upper right corner of the main page. The login page is displayed after you log out of the system.

4.2.2 Main Page Layout

On the main page, you can view real-time videos, receive alarm and fault notifications, set parameters, change the password, and log out of the system. Figure 4-19 shows the main page layout. Table 4-7 describes the elements on the main page.

Figure 4-19 Main page layout

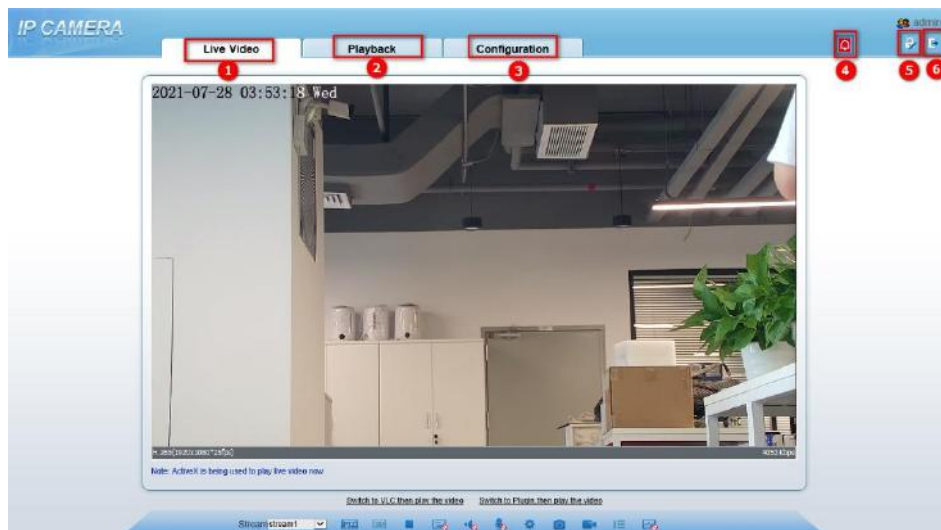







Table 4-7 Elements on the main page

No.	Element	Description
1	Real-time video area	Real-time videos are played in this area. You can also set sensor parameters.
2	Playback	You can query the playback videos in this area. NOTE Only when the SD card or NAS have videos that you can query the playback videos.
3	Device configuration	You can choose a menu to set device parameters, including the device information, audio and video streams, alarm setting, and privacy mask function.
4	Alarm icon	When the device generates an alarm, the alarm icon  is displayed. You can click  to view the alarm information. NOTE When the device accepts an alarm signal, the alarm icon will display within 10 s in the web management system.
5	Change password	You can click  to change the password.

No.	Element	Description
6	Sign Out	You can click  to return to the login page.

 **NOTE**

When the device encounters an exception, the fault icon  is displayed.

You can click  to view the fault information.

---End

4.2.3 Change the Password

Description

You can click  to change the password for logging in to the system.

Procedure

Step 1 Click  in the upper right corner of the main page.

The **Change Password** dialog box is displayed, as shown in Figure 4-20.

Figure 4-20 Modify Password dialog box

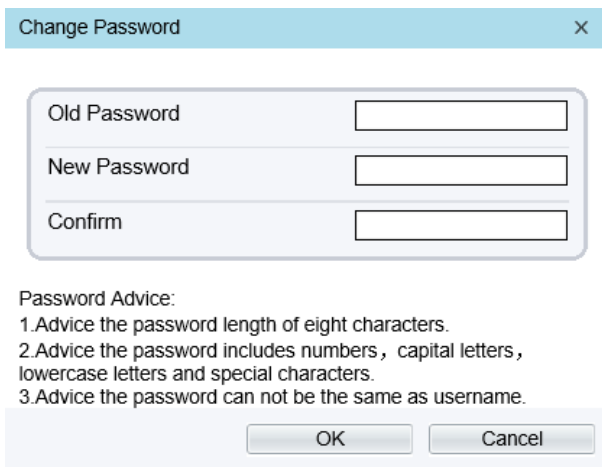

The dialog box titled "Change Password" has a close button (X) in the top right corner. It contains three input fields: "Old Password", "New Password", and "Confirm". Below the input fields is a "Password Advice" section with three numbered instructions: 1. Advice the password length of eight characters. 2. Advice the password includes numbers, capital letters, lowercase letters and special characters. 3. Advice the password can not be the same as username. At the bottom of the dialog box are two buttons: "OK" and "Cancel".

 **NOTE**

The change password page will be displayed if you don't change the default password when you login the system for the first time.

Step 2 Enter the old password, new password, and confirmation password.

Step 3 Click **OK**.

If the message "Change password success" is displayed, the password is successfully changed. If the password fails to be changed, the cause is displayed. (For example, the new password length could not be less than eight.)

Step 4 Click **OK**.

The login page is displayed.

----End

4.2.4 Browse Video

User can browse the real-time video in the web management system.

Preparation

To ensure that real-time videos can be played properly, you must perform the following operations when you log in to the web management system for the first time:

Step 1 Open Internet Explorer. Choose **Tools > Internet Options > Security > Trusted sites > Sites**.

In the displayed dialog box, click **Add**, as shown in Figure 4-21.

Figure 4-21 Adding a trusted site

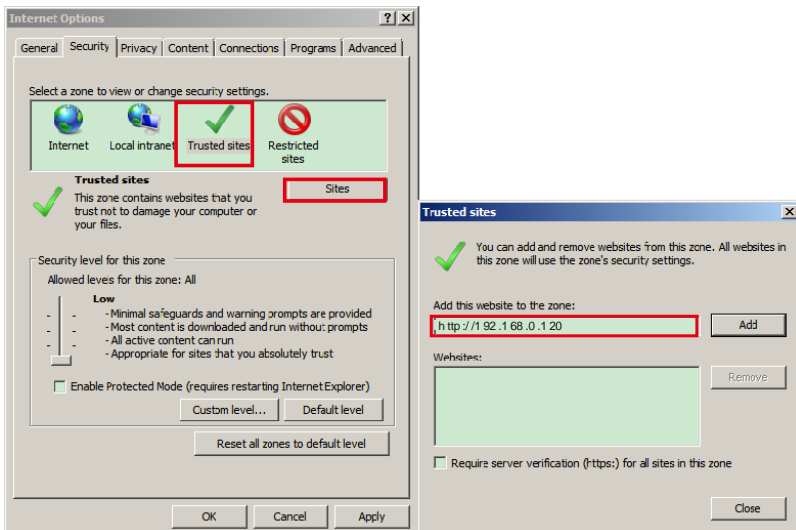

Step 2 In Internet Explorer, choose Tools > Internet Options > Security > Customer level, and set Download unsigned ActiveX controls and Initialize and script ActiveX controls not marked as safe for scripting under ActiveX controls and plug-ins to Enable, as shown in Figure 4-22.

Figure 4-22 Configuring ActiveX controls and plug-ins

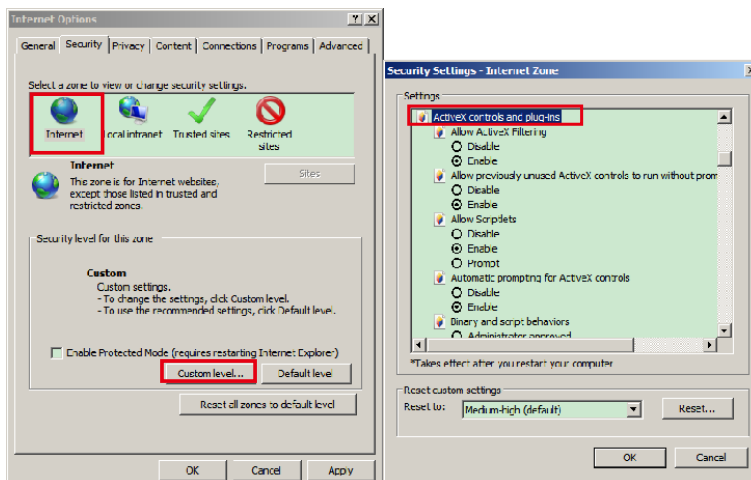

Step 3 Download and install the player control as prompted.

 **NOTE**

If the repair tips displayed when installing the control, please ignore the prompt, and continue the installation, the login page is displayed when the control is loaded.

Download the right control in the Internet Explorer

Real-time video page pop-ups the message **clicks to play live video with ActiveX control to reduce latency.**

Click the message, jump to download ActiveX control interface, once downloading is complete, you can watch more fluent video screen.

Unable to display video picture, and need to download and install the control

Real-time video page pop-up the message **click to download the latest version of Flash Play live video and click to play video with ActiveX control to reduce latency.**

Click the message **click to play live video with ActiveX control to reduce latency**, jump download Adobe Flash Player Plugin control interface, once downloading is complete, you can watch video screen.

Click the message **click to download the latest version of Flash Play live video**, jump to download ActiveX control interface, once downloading is complete, you can watch more fluent video screen.

In the Google, Firefox, or Safari browsers watch real-time video

Google, Firefox, and Safari browsers only support Adobe Flash Player Plugin to play video. When Adobe Flash Plugin control version is too low, browser will automatically clew you to download the latest control.

---End

4.2.5 Set Local Network Parameters

Description

Local network parameters include:

- IP protocol
- IP address
- Subnet mask
- Default gateway
- Dynamic Host Configuration Protocol (DHCP)
- Preferred Domain Name System (DNS) server
- Alternate DNS server
- MTU

Procedure

Step 1 Choose **Configuration > Device > Local Network**..

The **Local Network** page is displayed, as shown in Figure 4-23

Figure 4-23 Local Network page

 **Local Network**

Network Card ID

IP Protocol

DHCP OFF

IP Address

Subnet Mask

Default Gateway

Preferred DNS Server

Alternate DNS Server

MTU(1280-1500)

Step 2 Set the parameters according to Table 4-8.

Table 4-8 Local network parameters

Parameter	Description	Setting
IP Protocol	IPv4 is the IP protocol that uses an address length of 32 bits.	[Setting method] Select a value from the drop-down list box. [Default value] IPv4
Obtain IP address automatically	The device automatically obtains the IP address from the DHCP server.	[Setting method] Click the button on to enable DHCP . NOTE To query the current IP address of the device, you must query it on the platform based on the device name.
DHCP IP	IP address that the DHCP server assigned to the device.	N/A

Parameter	Description	Setting
IP Address	Device IP address that can be set as required.	[Setting method] Enter a value manually. [Default value] 192.168.0.120
Subnet Mask	Subnet mask of the network adapter.	[Setting method] Enter a value manually. [Default value] 255.255.255.0
Default Gateway	This parameter must be set if the client accesses the device through a gateway.	[Setting method] Enter a value manually. [Default value] 192.168.0.1
Preferred DNS Server	IP address of a DNS server.	[Setting method] Enter a value manually. [Default value] 192.168.0.1
Alternate DNS Server	IP address of a domain server. If the preferred DNS server is faulty, the device uses the alternate DNS server to resolve domain names.	[Setting method] Enter a value manually. [Default value] 192.168.0.2
MTU(1280-1500)	Set the maximum value of network transmission data packets.	[Setting method] Enter a value manually. NOTE The MTU value is range from 1280 to 1500, the default value is 1500, Please do not change it arbitrarily.

Step 3 Click **Apply**.

- If the message "Apply succeed!" is displayed, click Confirm. The system saves the settings. The message "Set network parameter success, Please login system again" is displayed. Use the new IP address to log in to the web management system.

- If the message "Invalid IP Address", "Invalid Subnet Mask", "Invalid default gateway", "Invalid primary DNS", or "Invalid space DNS" is displayed, set the parameters correctly.

---End

5 Sensor Settings

5.1 Access the Sensor Setting Interface

Operation procedure:

- Step 1 On the web interface or client interface, move the cursor to the real-time video page and right-click on the page. A shortcut menu is displayed, as shown in Figure 5-1, and Table 5-1 describes the sensor setting interface.

Figure 5-1 Sensor Setting interface

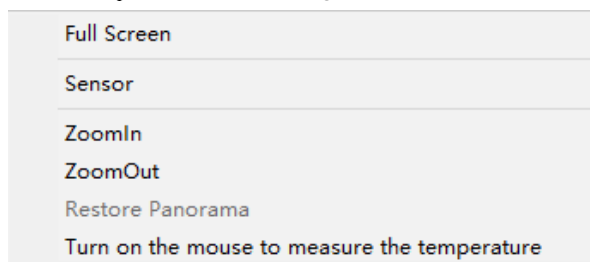

Table 5-1 Sensor Setting interface

Parameter	Description
Full Screen	It enlarges and displays the image in full screen.
Sensor Configure	It is used for configuring the parameter set of front-end images.
Zoom In/Out	It zooms in/out images by electronic means. This function may also be used with the mouse wheel.
Open point measurement (Turn on the mouse to measure the temperature)	Click this option to measure the target temperature that the mouse moved.

- Step 2 Choose **Sensor Configure** and the **Sensor Setting** dialog box appears.

----End

5.2 Sensor Setting Parameters of Thermal

5.2.1 Mode

Operation procedure:

Step 1 Click **Mode** tag on sensor setting interface, the Mode page is displayed, as shown in Figure 5-2.

Figure 5-2 Mode page

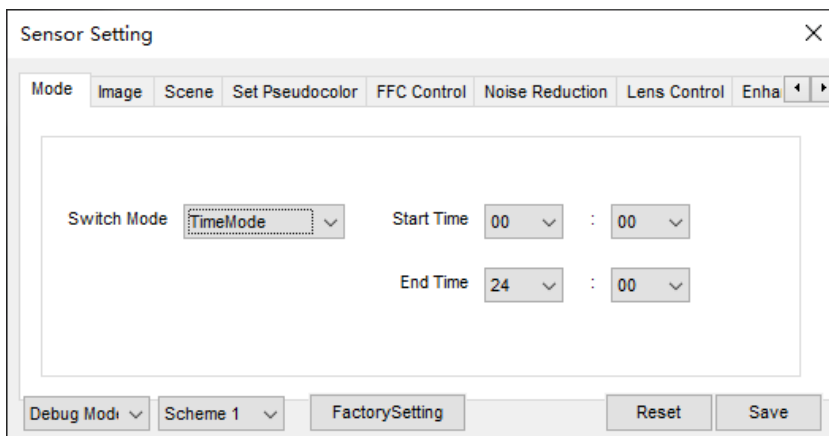

Step 2 Choose Debug Model in the lower left corner to activate the sensor setting page.

Step 3 Set the Mode parameters.

Step 4 Click **Save** to save the setting.

---End

5.2.2 Image Setting

Figure 5-3 shows the image setting interface.

Figure 5-3 Image setting interface

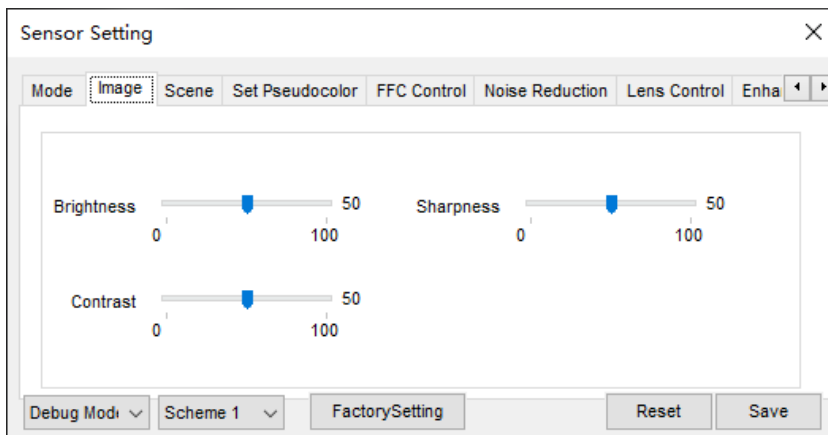

Table 5-2 describes the image setting parameters.

Table 5-2 Image setting parameter description

Parameter	Description	Setting
Brightness	It indicates the total brightness of an image. As the value increases, the image becomes brighter.	[Setting method] Drag the slider. [Default value] 50
Contrast	It indicates the contrast between the bright part and the dark part of an image. As the value increases, the contrast increases.	[Setting method] Drag the slider. [Default value] 50
Sharpness	It indicates the sharpness of the image plane and the sharpness of the image edge. The sharper the image, the better detail contrast.	[Setting method] Drag the slider. [Default value] 50

---End

5.2.3 Scene

Figure 5-4 shows the scene interface.

Figure 5-4 Scene interface

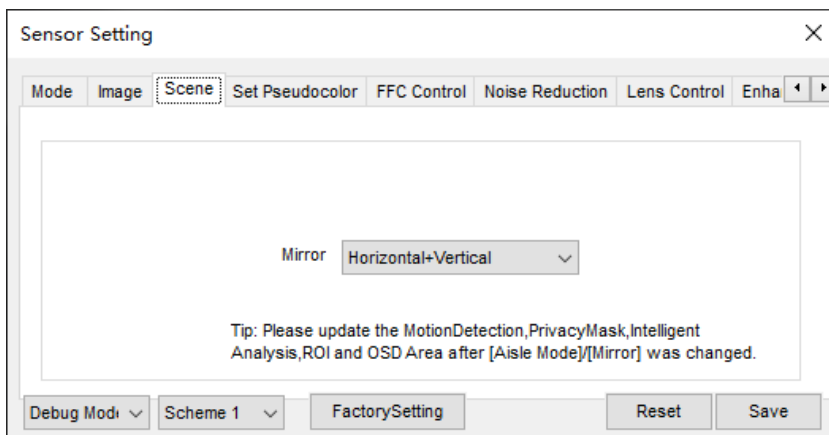

Provide the selection of image pixel locations.

Normal: the image is not flipped.

Horizontal: the image is flipped left and right.

Vertical: the image is flipped up and down.

Horizontal + Vertical: the image upside-down and reversal.

----End

5.2.4 Set Pseudocolor

Figure 5-5 shows the set pseudocolor interface.

Figure 5-5 set pseudocolor interface

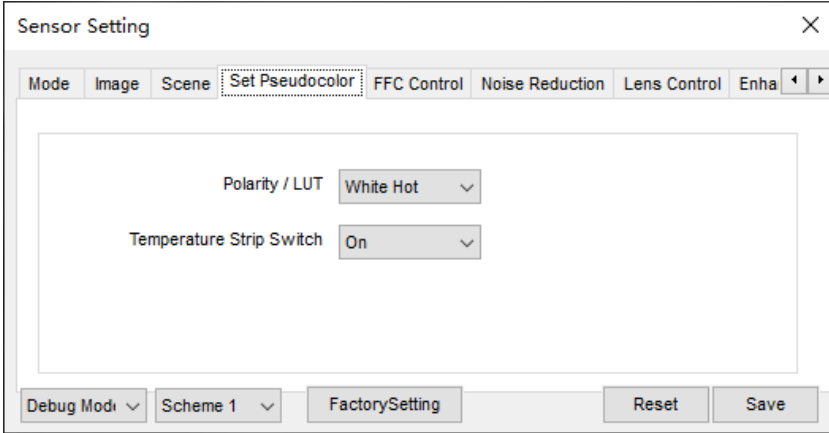

Polarity/LUT: the temperatures of the temperature fields detected by the thermal imaging camera are separately mapped to values ranging from 0 to 255 by the algorithm. In the black/white display mode, this range is converted to the grayscale tones. For example, 0 indicates completely black, and 255 indicates completely white. The temperature field of the scene is converted to images by using the grayscale ranging from 0 to 255. Different polarity modes can be converted to different display images. The most common setting is white hot (a hotter object is displayed brighter than a colder object) or black hot (a hotter object is displayed darker than a colder object). The difference between two modes lies in that the temperatures corresponding to the darker one and the lighter one are reversed. Other modes include rainbow, ironbow, HSV, autumn, bone and so on.

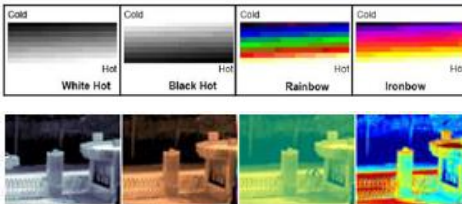

Temperature strip switch is on, the live video will show it, otherwise is no strip.
---End

5.2.5 FFC Control

Figure 5-6 shows the FFC mode interface.

Figure 5-6 FFC mode interface

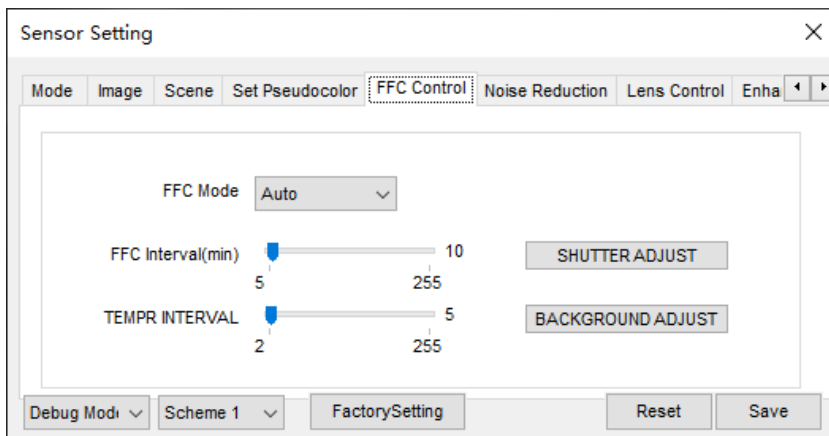

Table 5-3 describes the FFC mode parameters.

Table 5-3 FFC control parameter description

Parameter	Description	Setting
FFC Mode	<p>The internal of the thermal imaging camera may comprise the mechanical action correction mechanism that can periodically improve the image quality. This component is called flat field correction (FFC). When controlling the FFC, the FFC shields the sensor array, so that each portion of the sensor can collect uniform temperature fields (flat field). By means of FFC, the camera can update the correction coefficients to output more uniform images. Throughout the FFC process, the video image is frozen for two seconds and a static-frame image is displayed. After the FFC is complete, the image is automatically recovered. Repeated FFC operations can prevent the grainy and image degradation problems. The FFC is especially important when the temperature of the camera changes. For example, after the camera is powered on or the ambient temperature is changed, you should immediately perform the FFC.</p> <p>Auto: In the Automatic FFC mode, the camera performs FFC whenever its temperature changes by a specified amount or at the end of a specified period of time (whichever comes first). When this mode is selected, the FFC interval (minutes) ranges from 5 to 30 minutes. The temperature</p>	<p>[How to set] Select from the drop-down list box. [Default value] Auto</p>

Parameter	Description	Setting
	<p>change of the camera is based on the temperatures collected by the internal temperature probe. The temperature of the camera sharply changes when the camera is powered on. The FFC is relatively frequent, which is normal.</p> <p>Manual: In the manual FFC mode, the camera does not automatically perform the FFC based on the temperature change or the specified period. You can press the Do FFC button to select the manual FFC mode. When you feel that the image is obviously degraded but the automatic FFC is not performed, you can use the manual FFC function to check whether the image quality can be improved.</p>	
FFC Interval (min)	In the automatic FFC mode, the FFC interval ranges from 10 to 255 minutes.	[How to set] Drag the slider. [Default value] 15
Temper Interval	In the automatic FFC mode, the FFC interval ranges from 0.2 to 25.5 centigrade.	[How to set] Drag the slider. [Default value] 5
Shutter Adjust	Click the icon to adjust exposure immediately.	N/A
Background Adjust	Click the icon and cover the camera with something to adjust image. Remove the thing to finish adjustment.	N/A

---End

5.2.6 Lens Control

NOTE

The lens control is only used for motor lens.

Figure 5-7 shows the **Lens Control** interface.

Figure 5-7 Lens control interface

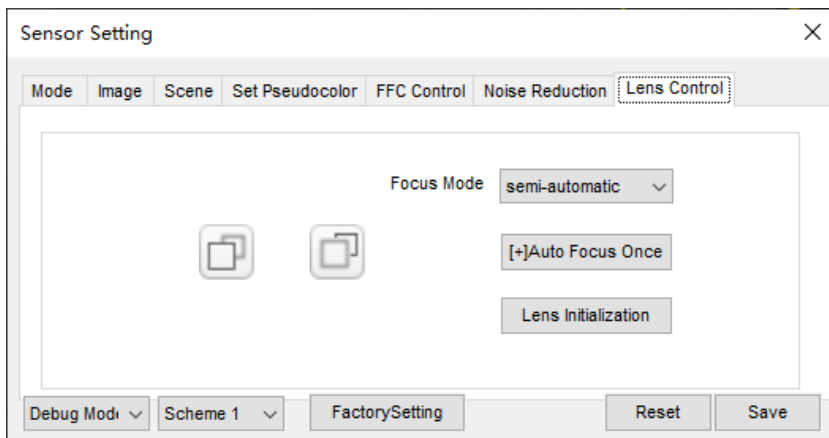

- Step 2 Click **Standard** in the lower left corner of Sensor Setting, and choose **lens control**.
- Step 3 Click “Near focus” or “Far focus” to focus automatically.
- Step 4 Choose focus mode, there are two modes can be chosen, semi-automatic and manual.
- Step 5 Click “Auto focus once” to focus once.
- Step 6 Click “Lens initialization” to initialize the lens.
- Step 7 Click **Save**, the message "Save succeed" is displayed, the system saves the settings.

---End

5.2.7 Noise Reduction

Figure 5-8 shows the Noise reduction interface.

Figure 5-8 Noise reduction interface

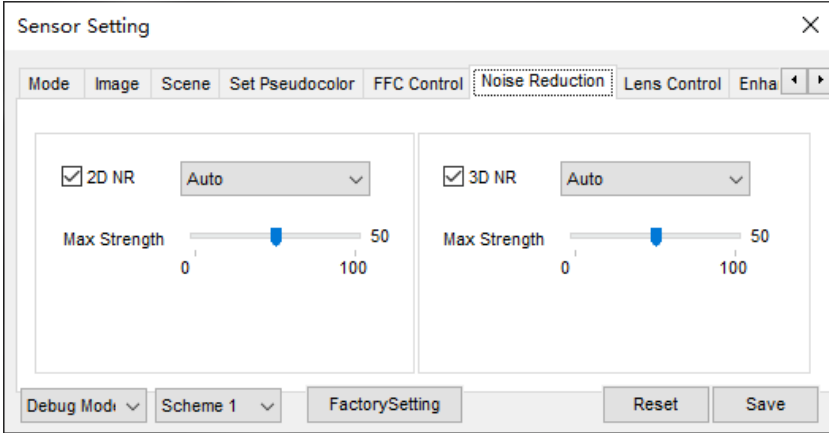

Table 5-4 describes noise reduction parameters.

Table 5-4 DNR parameter description

Parameter	Description	Setting
2 DNR	Decrease the image noise.	[How to set] Select from the drop-down list box. Drag the slider to adjust max strength. [Default value] Auto
3 DNR	Decrease the image noise.	[How to set] Select from the drop-down list box. Drag the slider to adjust max strength. [Default value] Auto

---End

5.2.8 Enhance Image

Figure 5-9 shows the screen adjustment interface and as shows in Figure 5-9 the screen adjustment parameter.

Figure 5-9 Enhance image interface

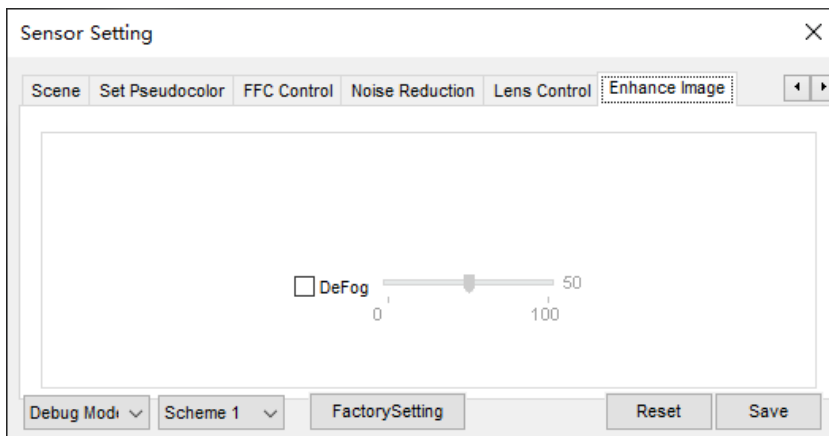

Tick the defog and drag the slider to adjust the value.

Click **Save** to save the parameters.

----End

5.3 Sensor Setting Parameters of Visible Light

5.3.1 Mode

Step 1 Click **Standard** in the lower left corner of Sensor Setting, and choose **Debug Mode**. As shown in Figure 5-10.

Figure 5-10 Mode

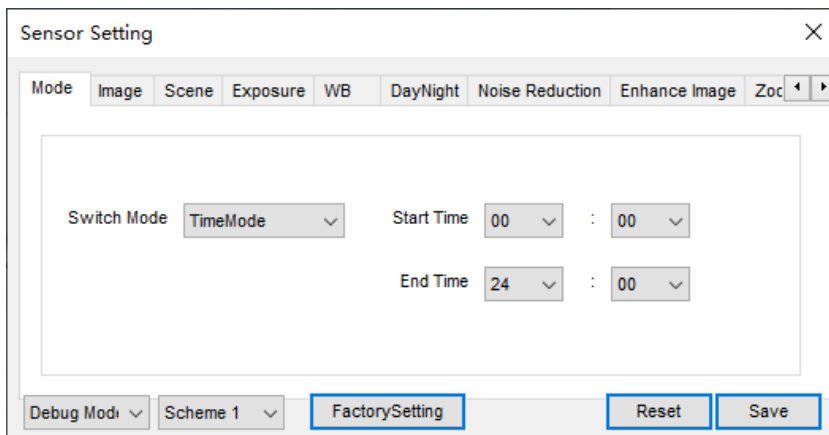

- Step 2 Choose the switch mode from the drop-down list.
- Step 3 Time mode: Set the Start Time, set the End Time. DN linkage Mode, the day mode is correspond to scheme 1, the night mode is correspond to scheme 2.
- Step 4 Click **Save**, the message "**Save succeed**" is displayed, the system saves the settings.

---End

5.3.2 Image Adjust

Figure 5-11 shows the Image Adjust tab page.

Figure 5-11 Image

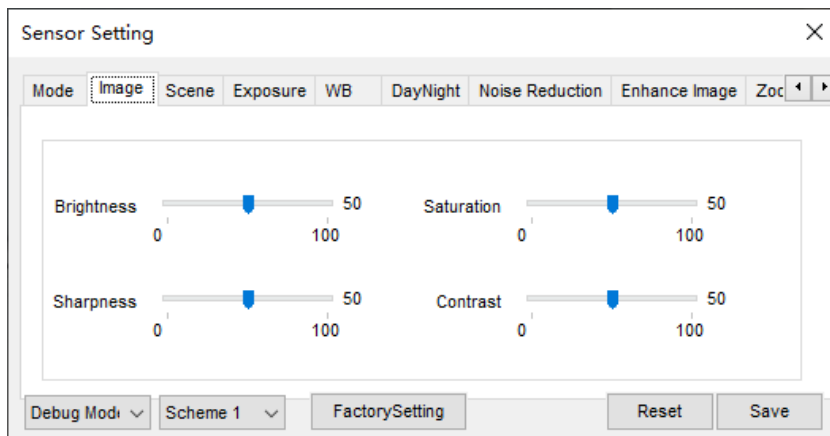

Table 5-5 describes the parameters on the Image Adjust tab page.

Table 5-5 Parameters of Image

Parameter	Description	Configuration Method
Brightness	It indicates the total brightness of an image. As the value increases, the image becomes brighter.	[Setting method] Drag the slider. [Default value] 50
Sharpness	It indicates the border sharpness of an image. As the value increases, the borders become clearer, and the number of noise points increases.	[Setting method] Drag the slider. [Default value] 50
Saturation	It indicates the color saturation of an image. As the value increases, the image becomes more colorful.	[Setting method] Drag the slider. [Default value] 50
Contrast	It indicates the measurement of different brightness levels between the brightest white and darkest black in an image. The larger the difference range is, the greater the contrast; the smaller the difference range is, the smaller the contrast	[Setting method] Drag the slider. [Default value] 50

---End

5.3.3 Scene

Figure 5-12 shows the scene tab page.

Figure 5-12 Scene

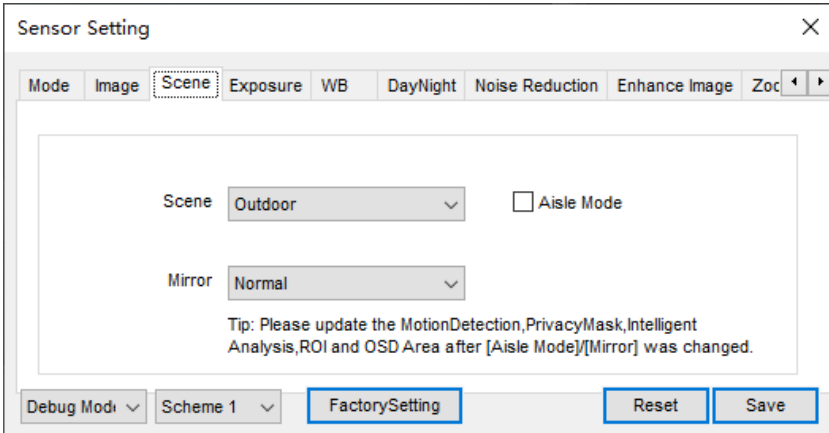

Table 5-6 describes the parameters on the scene tab page.

Table 5-6 Parameters of scene

Parameter	Description	Configuration Method
Scene	Indoor or outdoor.	[Setting method] Select a value from the drop-down list. [Default value] Outdoor
Mirror	It is used to select the pixel location of an image. <ul style="list-style-type: none"> • Normal: The image does not flip. • Horizontal: The image flips to the left and right. • Vertical: The image flips up and down. • Horizontal+ Vertical: The image rotates at 180 degrees. 	[Setting method] Select a value from the drop-down list. [Default value] Normal

Aisle Mode	The image rotates 90 degrees clockwise when aisle mode is enabled.	[Setting method] Tick the Freeze status. [Default value] Disable
------------	--	---

---End

5.3.4 Exposure

Figure 5-13 shows the Exposure tab page.

Figure 5-13 Exposure

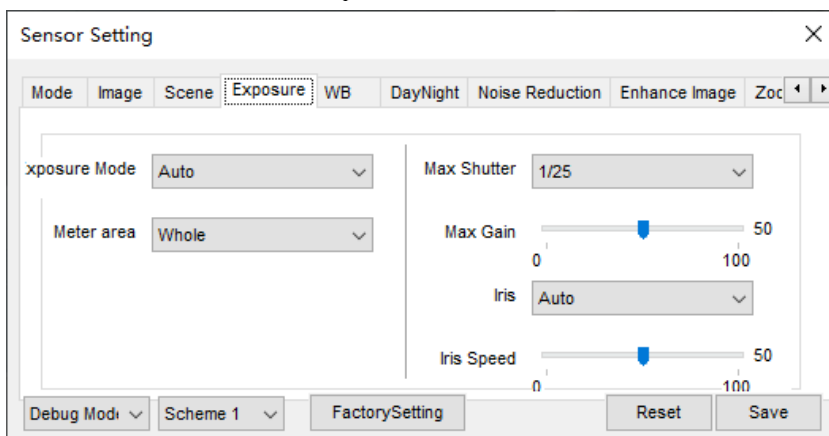



Table 5-7 describes the parameters on the Exposure setting tab page.

Table 5-7 Parameters of exposure setting

Parameter	Description	Configuration Method
Exposure Mode	<p>The exposure modes include:</p> <ul style="list-style-type: none"> • Auto: The system performs auto exposure based on the monitoring environment. • Manual: You can set Shutter Setting to fixed values manually. • Shutter Priority: You can set Iris Setting to fixed values. The shutter and gain are automatically adjusted by the system. 	<p>[Setting method] Select a value from the drop-down list. [Default value] Auto</p>

Meter area	Choose the area to meter, there are whole, center spot, and center area.	[Setting method] Select a value from the drop-down list. [Default value] Whole
Max Shutter	It is valid in Iris Priority mode. You can select a maximum shutter speed. As the value increases, the image becomes brighter.	[Setting method] Select a value from the drop-down list. [Default value] 1/25
Max gain	It indicates the maximum gain. The device automatically adjusts the gain based on the external light, and the gain is less than or equal to the value of this parameter.	[Setting method] Drag the slider. [Default value] 50
Iris	It is used to control the light admitted to the lens. The auto iris can be set to either of the following states: <ul style="list-style-type: none"> • Auto The iris is automatically adjusted to control the light admitted to the lens. • Open fully The iris is fully open. 	[Setting method] Select a value from the drop-down list. [Default value] Auto
Iris Speed	It indicates the auto adjustment speed of the iris. As the value increases, the speed increases. Excessive speed may cause instability.  NOTE This parameter is valid when the auto iris is enabled.	[Setting method] Drag the slider. [Default value] 50

---End

5.3.5 WB

Figure 5-14 shows the WB tab page.

Figure 5-14 WB

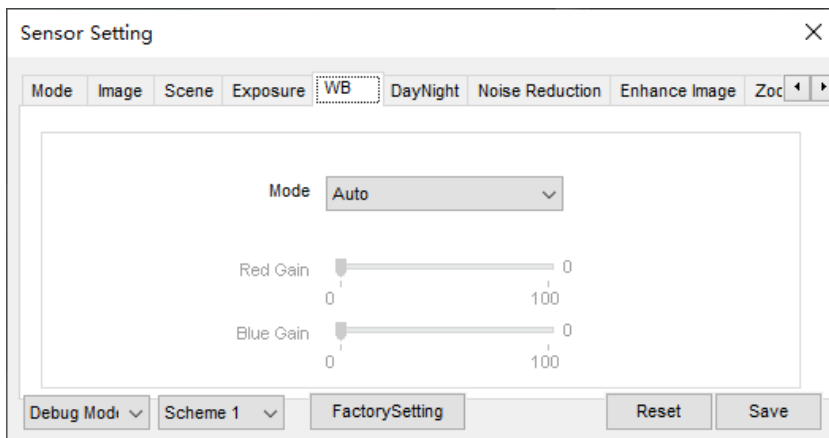

Table 5-8 describes the parameters on the WB tab page.

Table 5-8 Parameters of WB

Parameter	Description	Configuration Method
Mode	<p>It is used to display the real color of a monitoring scenario when the color temperature changes.</p> <ul style="list-style-type: none"> • Auto: camera adjusts automatically. • Tungsten: at tungsten lamp environment. • Fluorescent: fluorescent environment. • Daylight: at daylight environment. • Shadow: at low light environment. • Manual: adjust red and blue gain manually. 	<p>[Setting method] Select a value from the drop-down list. [Default value] Auto</p>

---End

5.3.6 DayNight

Figure 5-15 shows the day-night tab page.

Figure 5-15 Day-night

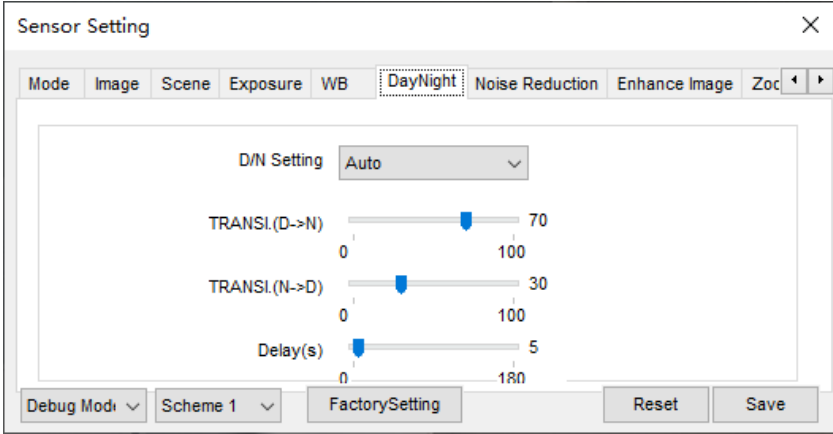

Table 5-9 describes the parameters on the day night tab page.

Table 5-9 Parameters of day night

Parameter	Description	Configuration Method
DayNight Mode	<p>It can be set to Auto, Day Mode, Night Mode and Timing.</p> <ul style="list-style-type: none"> Auto mode The image color is adjusted based on the day/night mode. In auto mode, the image switches between the colored state and the black and white state based on the brightness. In day mode, the image is colored. In night mode, the image is black and white. Day mode The image is colored, and the filter is in the day state, preventing infrared light from entering the sensor. Night mode The image is black and white, and the filter is in the night state, allowing all types of light to enter the sensor. Timing Select time from the drop-down list by the “Day To Night Time” and “Night To Day Time”. 	<p>[Setting method] Select a value from the drop-down list. [Default value] Day Mode</p>
Trans (D to N)	Day transit to night.	<p>[Setting method] Drag the slider. [Default value] 50</p>
Trans (N to D)	Night transform to day.	<p>[Setting method] Drag the slider. [Default value] 50</p>
Delay	N/A	<p>[Setting method] Drag the slider. [Default value] 5</p>

5.3.7 Noise Reduction

Figure 5-16 shows the noise reduction tab page.

Figure 5-16 Noise Reduction

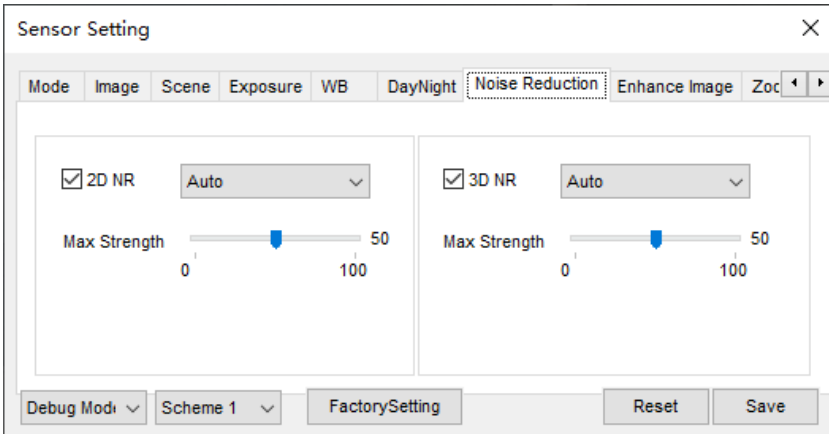

Table 5-10 describes the parameters on the noise reduction tab page.

Table 5-10 Parameters of noise reduction

Parameter	Description	Configuration Method
2D NR	Auto /manual, default value is auto. By comparing and screening the images of the two frames before and after, the noise point position is found out and gain control is carried out on them.	[Setting method] Drag the slider strength. [Default value] Auto / 50
3D NR	Auto /manual, default value is auto. The 3D digital noise reduction function can reduce the noise interference of the weak signal image.	[Setting method] Drag the slider of strength. [Default value] Auto / 50

---End

5.3.8 Enhance Image

Figure 5-17 shows the enhance image Setting tab page.

Figure 5-17 Enhance image

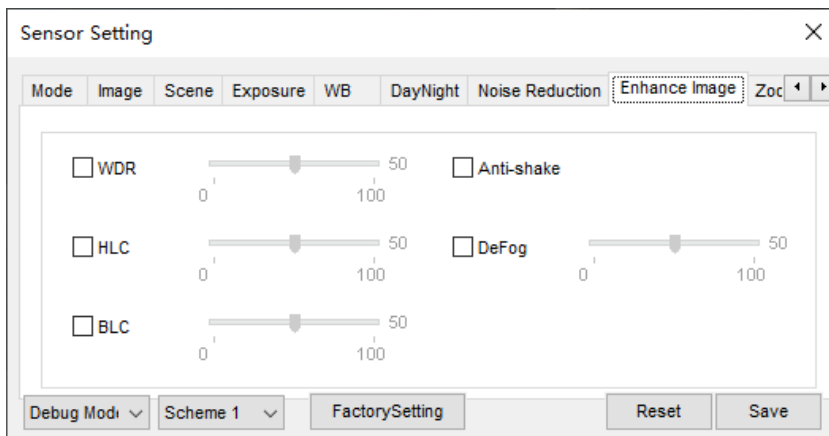



Table 5-11 describes the parameters on the enhance image setting tab page.

Table 5-11 Parameters of enhance image

Parameter	Description	Configuration Method
WDR	It is intended to provide clear image performance in strong backlight areas such as exterior light coming through a window or glass door. High contract light conditions are no longer a problem when you need to capture detailed images.	[Setting method] Drag the slider. [Default value] 50
HLC	It indicates reverse bright points in the picture to black. As an effective approach to recognize vehicle plate number at night, HLC function can detect any spotlight diffused by object-vehicle and compensate it for obtaining clearer image.	[Setting method] Drag the slider. [Default value] 50
BLC	It indicates Back Light Compensation (BLC) automatically brings more detail to darker areas of an image when bright light shining from behind obscures it and provides perfect exposure for an object in front of very strong back light. The electronic shutter of the camera basically adjusts its exposure to try to allow for more light to be allowed in the darker areas.  NOTE This parameter applies only to visible light.	[Setting method] Drag the slider. [Default value] 50

Anti-shake	When the camera shakes out, it is processed by algorithm compensation	[Default value] Disable
Defog	It indicates the camera defog automatically.	[Setting method] Drag the slider. [Default value] 50

---End

5.3.9 Zoom Focus

Figure 5-18 shows the enhance image Setting tab page.

Figure 5-18 Zoom focus

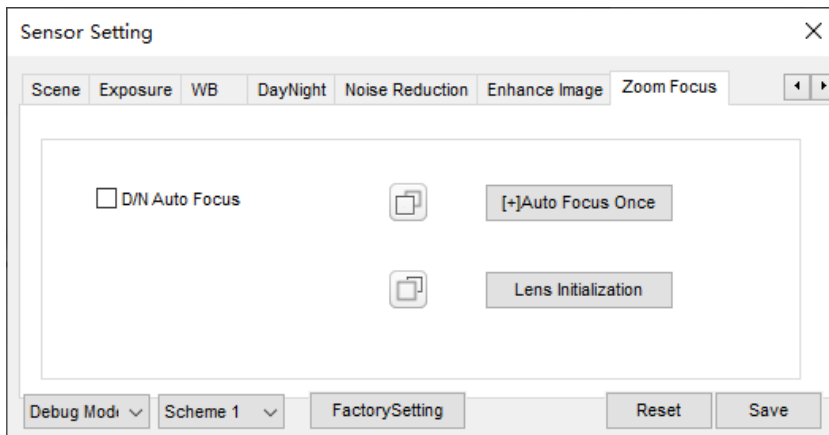

Table 5-12 describes the parameters on the enhance image setting tab page.

Table 5-12 Parameters of zoom focus

Parameter	Description	Configuration Method
D/N Auto Focus	Enable the function, if the day or night is transform, it will focus automatically.	[Setting method] Tick
--	<input type="checkbox"/> :near focus <input type="checkbox"/> :far focus	[Setting method] Click
Auto focus once	N/A	[Setting method] Click

Lens initialization	N/A	[Setting method] Click
---------------------	-----	---------------------------

---End

6 PTZ Function Application

6.1 PTZ Control function

Operation Description

PTZ Control function is only available to a camera with an external PTZ and High Speed Dome with PTZ function.

PTZ Control

When browsing real-time videos shot by a dome camera or a camera connected to an external PTZ, you can control the PTZ to view Video shot in different directions.





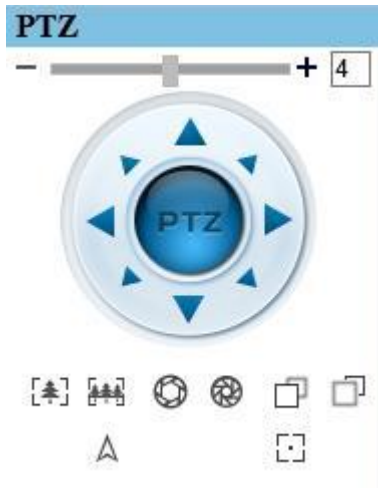



In the PTZ control area, you can click the eight arrow keys to move the PTZ in eight directions, as shown in Figure 6-1.

Figure 6-1 PTZ Control zone



It may also control the iris, zoom and focus of the camera lens through other buttons in the PTZ control zone. Functions of each button are as shown in Table 6-1.

Table 6-1 Descriptions of PTZ buttons

Button	Description
Auto Zoom	Click  or  to adjust the surveillance range of the front-end lens.
Auto Iris	Click  or  to adjust the size of the front-end iris.
Auto Focus	Click  or  to adjust the focus of the front-end lens.
Speed	Drag the slider on  to adjust the rotational speed of the PTZ.
North	Click  to set due north direction.
Focus	Click  to enable automatic focus function

---End

6.2 PTZ configuration

6.2.1 PTZ Setting

Click , the PTZ configuration interface displayed, as shown in Figure 6-2.

Figure 6-2 PTZ Configuration



Through this interface, you can perform the following operations:

- Add, Delete and Apply a Preset, Track, Scan and Tour.
- Set and enable Idle.
- Set the direction to due north.
- Any direction can be set as the reference due north.

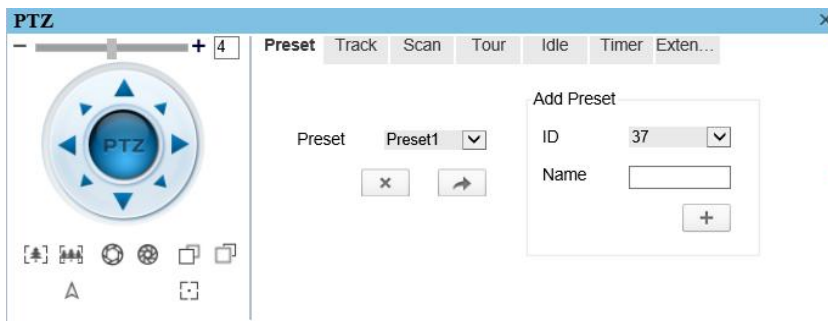
- Configure Timer.

----End

6.2.2 Configure and Apply Preset



You can configure preset positions and quickly rotate the camera to preset position by applying the preset.

Operation procedure

- Step 1 Click **Preset** tab page in the PTZ configuration interface, the add preset page is displayed, as shown in Figure 6-3.

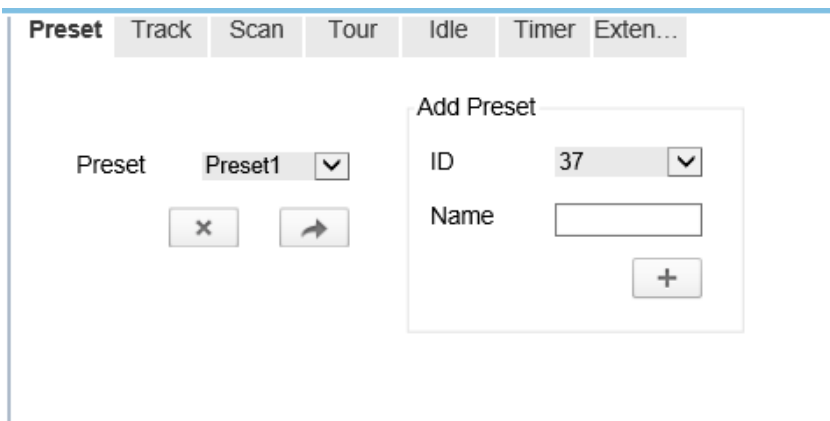
Figure 6-3 Add Preset



- Step 2 Select a preset ID (such as 1) from the Preset drop-down list box and enter the name of preset.
- Step 3 Use eight arrow keys in the **PTZ control** area to configure a position, then click  to complete adding a preset.
- Step 4 Select a Preset name from the Preset drop-down list box and click  to apply the preset.

NOTE

Up to 400 Presets can be configured

----End

6.2.3 Configure and Apply Tracks

You can record a track to allow the camera to repeatedly rotate based on the preset track.



Operation procedure

Step 1 Click **Track** tab page in the PTZ configuration interface, the add track page is displayed as shown in Figure 6-4.

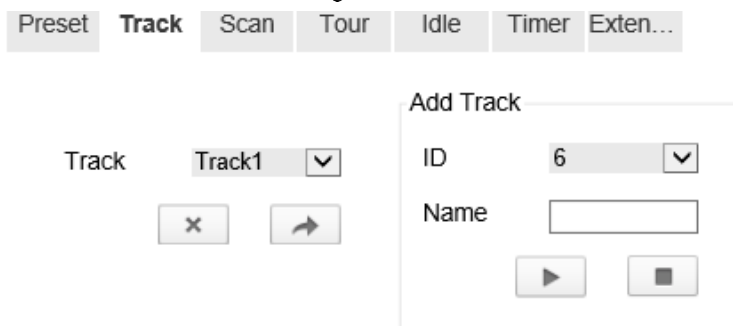
Figure 6-4 Add Track



Step 2 Select a track ID (such as 1) from the track drop-down list box and enter the name of track.

Step 3 Click , then use eight arrow keys in the **PTZ control** area to configure a track, then click  to complete adding a track.

Step 4 Select a Track name from the Track t drop-down list box and click  to apply the track.

NOTE

Up to 6 Tracks can be configured.

---End

6.2.4 Configure and Apply Scan



You can configure a Scan to rotate the camera between two positions by applying the Scan.

Operation procedure

Step 1 Click **Scan** tab page in the PTZ configuration interface, the add Scan page is displayed, as shown in Figure 6-5.

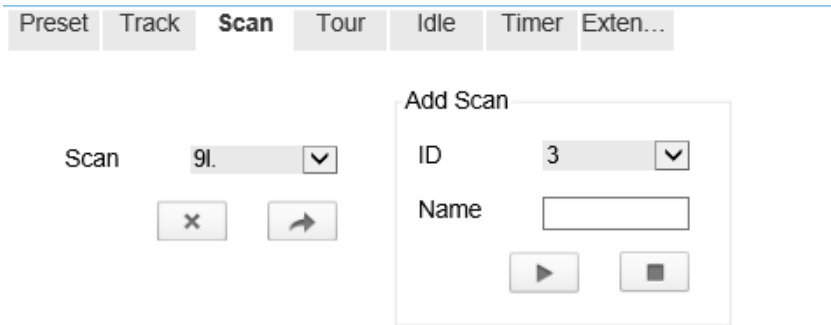
Figure 6-5 Add Scan



- Step 2 Select Scan ID (such as 1) from the track drop-down list box and enter the name of scan.
- Step 3 Click , then use eight arrow keys in the **PTZ control** area to configure two positions, then click  to complete adding a scan.
- Step 4 Select a Scan name from the Scan t drop-down list box and click  to apply the scan.
- End

6.2.5 Configure and Apply Tour





You can configure a tour to rotate the camera between presets set by PTZ.

Operation procedure

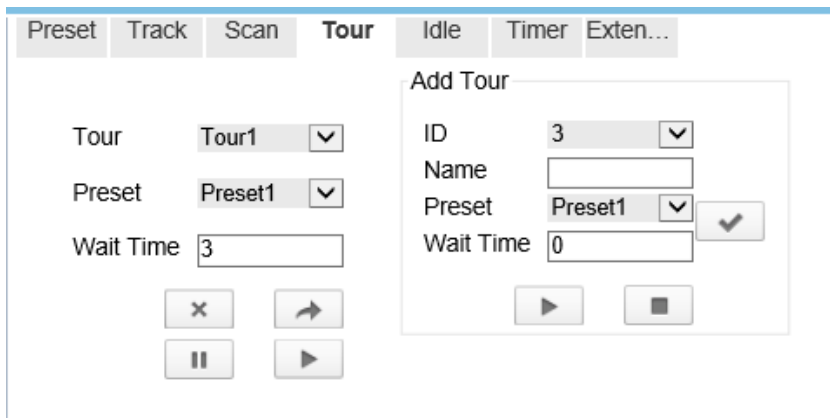
- Step 1 Click **Tour** tab page in the PTZ configuration interface, the add tour page is displayed, as shown in Figure 6-6.

Figure 6-6 Add Tour



- Step 2 Select Tour ID (such as 2) from the drop-down list box, enter the tour name.
- Step 3 Select first required position preset from the **Preset** drop-down list box.
- Step 4 Input the values from **Wait Time** area box to set the time to stay in this position preset.(0 sec~ 255 sec).
- Step 5 Click  button to begin setting tour.
- Step 6 Select next position preset form the preset drop-down list box, and then input the values from Wait Time area box to set the time to stay in next position preset.(0 sec~ 255 sec).
- Step 7 Click  to add the preset to tour.
- Step 8 Repeat former step until all required position presets are completed adding.
- Step 9 Click  to complete adding a tour (You also can click Cancel button to quit current setting).
- Step 10 Select a tour name and preset from the tour and preset drop-down list box, and then click  to apply the tour.

---End

6.2.6 Configure and Apply Idle

You can configure an idle to `apply preset. Scan, Track, or Tour regularly.



Operation procedure

- Step 1 Click **Idle** tab page in the PTZ configuration interface, the idle page is displayed, as shown in Figure 6-7.

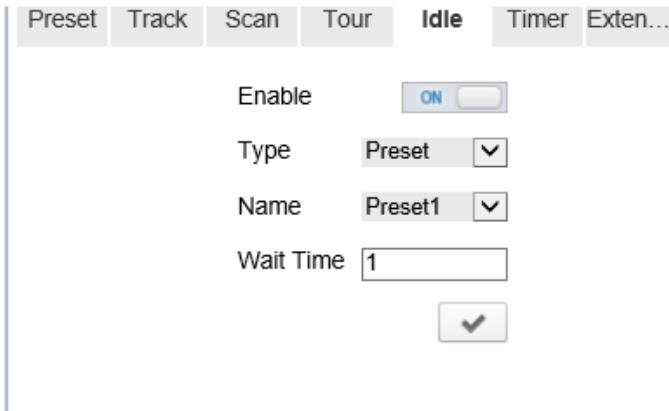
Figure 6-7 Idle



The screenshot shows the PTZ configuration interface with the 'Idle' tab selected. The 'Enable' toggle is turned ON. The 'Type' dropdown is set to 'Preset', the 'Name' dropdown is set to 'Preset1', and the 'Wait Time' input field contains the value '1'. A checkmark button is visible below the input field.

- Step 2 Select a monitor type from the **Type** drop-down list box. Monitor type can choose preset, Scan, track, tour and Cir Scan.
- Step 3 Select a name from the **Name** drop-down list box.
- Step 4 Input a value from the **Wait Time** area box.
- Step 5 Click  to completed adding an idle.
- Step 6 Click  to enable idle function.

---End

6.2.7 Configure Timer

Operation procedure

- Step 1 Click **Timer** tab page in the PTZ configuration interface, the set timer page is displayed, as shown in Figure 6-8.

Figure 6-8 Set Timer



Set the PTZ Timer





Step 2 Click , the Timer page is displayed, as shown in Figure 6-9.

Figure 6-9 Timer

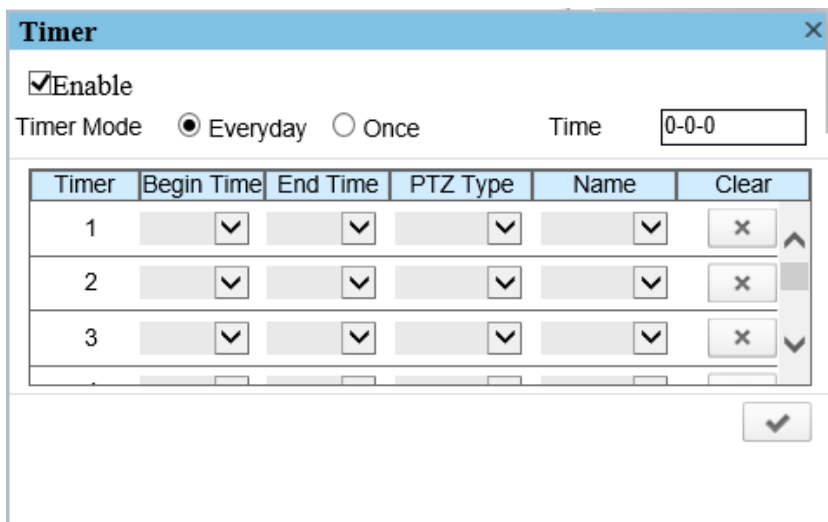

- Step 3 Check **Enable** box.
- Step 4 Select the timer mode.
- Step 5 Select the required begin time at the **Begin Time** drop-down list box, and then select the required end time at the **End Time** drop-down list box.
- Step 6 Select the required monitor type at the PTZ type drop-down list box, you can select preset, Scan, Track, Tour in the box, and then select a specific from the **Name** drop-down list box.(for example preset, 1).

Step 7 Repeat Step 5 and Step 6 to add more required time.

Step 8 Click  to complete timer setting.

----End

6.2.8 Configure Extension

You can use extension function including lamp and brush.

Operation procedure

Step 1 Click **Extension** tab page in the PTZ configuration interface, the extension page is displayed, as shown in Figure 6-10.

Figure 6-10 Extension

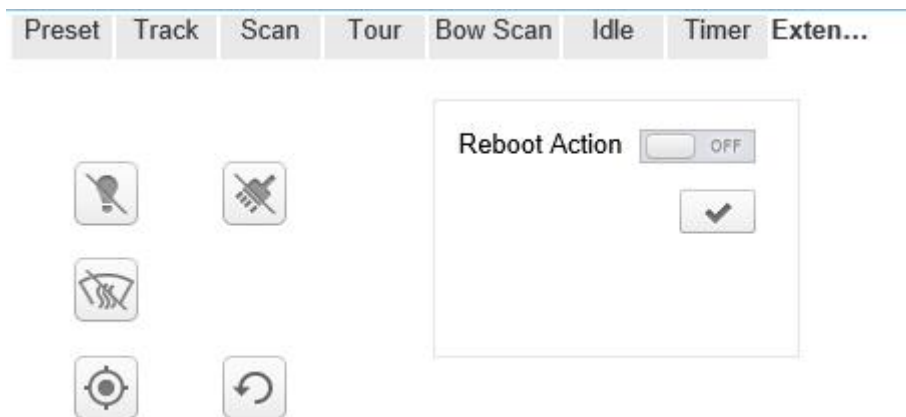

Step 2 Click  to enable the lamp.

Light On/Off is used to control the infrared camera shields on and off. It's available only to specific camera shields.

Click  to enable the brush.

Brush is used to clean the lens. It's available only to a camera with a brush or a camera shield.

Click  to enable the heater.

Heater is used to defog. It's available only to a camera with a heater.

Click  to do a self-inspection.

Click  to restore the PTZ to factory settings, the preset, track, scan, tour, and so on, all of these settings are restored immediately. Then the PTZ do a self-inspection.

---End

A Troubleshooting

Common Trouble	Possible Cause	Solution
Unable to access the web	Network is not connected.	<ul style="list-style-type: none"> Connect the network cable of the camera to the PC to check whether the network cable is in good contact. Run the ping command to check the network connection and whether the device works normally.
	IP address is occupied.	Directly connect the camera to the PC, and reset the IP address of the camera.
	The IP addresses of the PC and the device are in different networks.	Check the IP address, subnet mask and gateway setting of the camera.
PTZ or high speed dome is out of control.	The protocol, bit-rate, or address setting of the PTZ is incorrect.	Modify the address of the PTZ on the web.
	The signal cable is unconnected or not connected correctly.	Check the signal strength, and reconnect the signal cable.
The measured temperature is not accurate.	The device is just powered on, and the temperature of the cavity is unstable.	The temperature of the cavity is stable within 15 to 30 min after the device is powered on.
	The FFC mode is incorrect.	The FFC mode is auto by default. If the mode is set to manual, it will be no block calibration, which may lead to fuzzy pictures and inaccurate temperature.
	The target configuration is incorrect.	Check whether the emission rate and distance of the target are configured correctly.

Common Trouble	Possible Cause	Solution
An error occurs in accessing the web of the device after the upgrade.	The data in the cache of browser is not updated in time.	Delete the cache of the Internet Explorer. The steps are as follows (taking IE9 as an example): <ol style="list-style-type: none"> 1. Open the Internet Explorer. 2. Select Tools > Internet Options. 3. On the General tab, select Delete under Browsing history. The Delete Browsing History dialog box appears. 4. Select all check boxes. 5. Click Delete. Relogin the web page of the camera.
Upgrade failed.	No network cable is connected.	Ensure the upgrade network is connected.
	The network setting is incorrect.	Check whether the network setting is correct.
	The upgrade package is incorrect.	Perform the correct upgrade package again.
No self-test no image output	There is a broken line in the circuit	Find breakpoints, rewiring.
	Low supply voltage	Replace the power adapter to increase the output voltage.
Self-test exception	Low supply voltage	Replace the power adapter to increase the output voltage.
Equipment control is normal, image instability (Analog video)	Poor video circuit contact	Troubleshooting, rewiring
	Access device exception	Replacement access device
Equipment control is normal, image instability (Web video)	Network line bad contact	Dismantling bad point, re-wiring.
	Access to computer performance is insufficient, take up CPU usage	Lower stream and resolution

Common Trouble	Possible Cause	Solution
	Lack of network bandwidth	Replacement of industrial Gigabit switches
	Access decoder performance decoder	Replacement of high-performance decoder
Self-test normal, cannot control	Wrong wiring	Rewiring
	Set the baud rate, protocol, address and device mismatch	Screen configuration according to device parameters
Repeated restart	Insufficient supply voltage or voltage instability	To ensure that the input device voltage stability
Cannot control the lens to perform zoom and Focus action	Wiring error	Re-connect the lens control line
	Circuit board lens control problems	Replacement circuit board (please contact after-sales rework processing, do not replace parts or repair)
Cannot recall the set lens preset point	DIP switch relative to the set lens preset dialing is not set to ON	DIP switch control lens preset dialing dial into ON
The image is lost when the control device rotates	Rotation process at the same location lost image	Conductive slip ring there is a bad contact, replace the parts (please contact after-sales rework, do not replace parts or repair)

B Common Emission Rate

Emission Rate

The emission rate is the capability of an object to emit or absorb energy. An ideal transmitter provides an emission rate of emitting 100% of intake energy. An object with an emission rate of 0.8 can absorb 80% of intake energy, and reflect the remaining 20%. The emission rate is the ratio of the energy emitted by an object at a specific temperature to that emitted by an ideal radiator at the same temperature. The range of emission rate value is 0.0 to 1.0 generally.

Materials	Temperature (°C/°F)	Emissivity
Gold (High-purity)	227/440	0.02
Aluminum foil	27/81	0.04
Aluminum sheet	27/81	0.18
Aluminum used for families (flat)	23/73	0.01
Aluminum plate (98.3% purity)	227/440	0.04
	577/1070	0.06
Aluminum plate (rough)	26/78	0.06
Aluminum (oxidized @ 599°C)	199/390	0.11
	599/1110	0.19
Polished aluminum	38/100	0.22
Tin (light tinned Iron sheet)	25/77	0.04
Nickel wire	187/368	0.1
Lead (99.9% purity, No oxidized)	127/260	0.06

Copper	199/390	0.18
Cobalt	599/1110	0.19
Steel	199/ 90	0.52
	599/1110	0.57
Tinned iron sheet (Light)	28/82	0.23
Brass(High-polish)	247/476	0.03
Brass (Tough rolled, polished metal wire)	21/70	0.04
Tinned Iron (Light)	-	0.13
Iron plate (Rust eaten)	20/68	0.69
Rolled steel sheet	21/71	0.66
Ferric oxide	100/212	0.74
Wrought-iron	21/70	0.94
Fused iron	1299-1399/3270-2550	0.29
Copper (Polished)	21-117/70-242	0.02
Copper(Polished, not reflected)	22/72	0.07
Copper (Heavy oxide Board)	25/77	0.78
Enamel (Fuse on iron)	19/66	0.9
Formica Plate	27/81	0.94
Frozen soil	-	0.93
Brick (Red, rough)	21/70	0.93
Brick (Unglazed, rough)	1000/1832	0.8

Carbon (T - carbon 0.9% ash)	127/260	0.81
Concrete	-	0.94
Glass (Glossy)	22/72	0.94
Granite (Surfaced)	21/70	0.85
Ice	0/32	0.97
Marble (I Polished, grey)	22/72	0.93
Asbestos board	23/74	0.96
Asbestos paper	38/100	0.93
	371/700	0.95
Asphalt (Paving the road)	4/39	0.97
Paper (Black tar)	-	0.93
Paper (White)	-	0.95
Plastic (White)	-	0.91

101-500-0248-02